

Projector

PV800UL-W/PV800UL-B
PV710UL-W/PV710UL-B

Installation Manual

Model No.

NP-PV800UL-W/NP-PV800UL-B/NP-PV710UL-W/NP-PV710UL-B

Table of Contents

Introduction	iv
Important Information	v
1. Check the product overview, supplied items and part names	1
1-1. Introduction to the Projector	1
1-2. What's in the Box?	3
1-3. Part Names of the Projector	4
1-4. Part Names of the Remote Control	9
2. Projecting an Image (Basic Operation)	16
2-1. Flow of Projecting an Image	16
2-2. Connecting Your Computer/Connecting the Power Cord	17
2-3. Turning on the Projector	19
2-4. Selecting a Source	22
2-5. Adjusting the Picture Size and Position	24
2-6. Adjusting a picture and sound	34
2-7. Turning off the Projector	35
2-8. After Use	36
3. Convenient Features	37
3-1. Turn off the light of the projector (SHUTTER)	37
3-2. Turning Off the On-Screen Menu (On-Screen Mute)	37
3-3. Enlarging a Picture	38
3-4. Adjustment of luminance (brightness)	39
3-5. Correcting Keystone Distortion [KEystone]	43
3-6. Preventing the Unauthorized Use of the Projector [SECURITY]	49
3-7. Controlling the Projector by Using an HTTP Server	52

4. Using On-Screen Menu	58
4-1. Using the Menus	58
4-2. List of Menu Items	61
4-3. Menu Descriptions & Functions [INPUT]	65
4-4. Menu Descriptions & Functions [ADJUST]	66
4-5. Menu Descriptions & Functions [SETUP]	72
4-6. Menu Descriptions & Functions [INFO.]	88
4-7. Menu Descriptions & Functions [RESET]	90
5. Attach the lens unit, accessories, etc.	91
5-1. Mounting a lens (sold separately)	91
5-2. Attaching the strap (supplied)	95
5-3. Attaching the power cord stopper (supplied)	96
5-4. Mounting the cable cover (sold separately)	97
6. Connecting to Other Equipment	99
6-1. Connecting Your Computer	99
6-2. Connecting audio video equipment	100
6-3. Connecting to a HDBaseT transmission device (sold commercially)	101
6-4. Connecting to a Wired LAN	102
7. Maintenance	103
7-1. Cleaning the Lens	103
7-2. Cleaning the Cabinet	104
7-3. Cleaning the Filters	105
7-4. Replacing the filters	109

8. Appendix	112
8-1. Throw distance and screen size	112
8-2. Compatible Input Signal List	122
8-3. Specifications	123
8-4. Cabinet Dimensions	126
8-5. Pin assignments and signal names of main connectors	127
8-6. Changing the Background Logo (Virtual Remote Tool)	129
8-7. Portrait projection (vertical orientation)	130
8-8. Troubleshooting	132
8-9. PC Control Codes and Cable Connection	137
8-10. About the ASCII Control Command	139
8-11. Troubleshooting Check List	141
8-12. REGISTER YOUR PROJECTOR! (for residents in the United States, Canada, and Mexico)	143

Introduction

Thank you for purchasing the NEC projector.

This projector can be connected to computers, video devices, etc. to project images sharply onto a screen.

Please read this manual carefully before using your projector.

Read this manual if you have any doubts about operation or if you believe the projector may be faulty.

NOTES



- (1) The contents of this manual may not be reprinted in part or whole without permission.
- (2) The contents of this manual are subject to change without notice.
- (3) Great care has been taken in the preparation of this manual; however, should you notice any questionable points, errors or omissions, please contact us.
- (4) The image shown in this manual is indicative only. If there is inconsistency between the image and the actual product, the actual product shall govern.
- (5) Notwithstanding article (3) and (4), we will not be responsible for any claims on loss of profit or other matters deemed to result from using this device.
- (6) This manual is commonly provided to all regions so they may contain descriptions that are pertinent for other countries.

Important Information









About the symbols

To ensure safe and proper use of the product, this manual uses a number of symbols to prevent injury to you and others as well as damage to property.

The symbols and their meanings are described below. Be sure to understand them thoroughly before reading this manual.

 WARNING	Failing to heed this symbol and handling the product erroneously could result in accidents leading to death or major injury.
 CAUTION	Failing to heed this symbol and handling the product erroneously could result in personal injury or damage to surrounding property.

Examples of symbols

	This symbol indicates you should be careful of electric shocks.
	This symbol indicates you should be careful of high temperatures.
	This symbol indicates something that must be prohibited.
	This symbol indicates something that must not be got wet.
	This symbol indicates you should not touch with wet hands.
	This symbol indicates something that must not be disassembled.
	This symbol indicates things you must do.
	This symbol indicates that the power cord should be unplugged from the power outlet.

Safety Cautions

WARNING

Projected light



PROHIBITED

Projected light and the pictogram/label indicated on the cabinet

- Do not look into the projector's lens. Strong light that could damage your vision is projected when the projector is operating. Laser energy exposure near aperture may cause burns. Be especially careful when children are around.
- Do not look at the projected light using optical devices (magnifying glasses, reflectors, etc.). Doing so could result in vision impairment.
- Check that there is no one looking at the lens within the projection range before turning on the projector.
- Do not allow children to operate the projector alone. When a child is operating the projector an adult should always be present and watch the child carefully.
- The below pictogram, that is indicated near the lens on the cabinet, describes looking into the projector is prohibited.

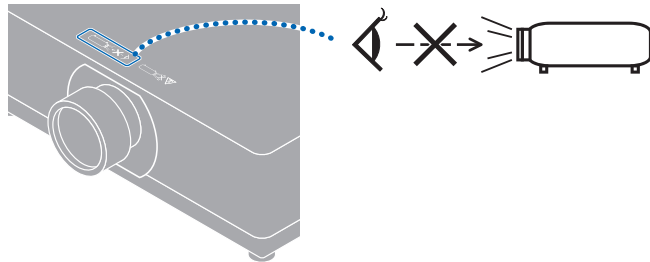

Continue to next page



WARNING

- The following labels are stuck on the projector.

Label 1 Laser Explanatory Label



Label 2 FDA additional warning label

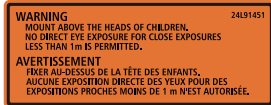

Label 3 Lens replacement caution label

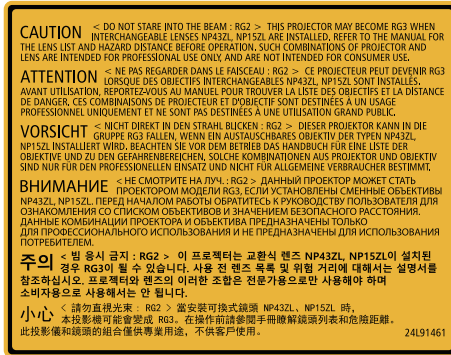

- This projector is classified as either IEC/EN 62471-5 First edition risk group 2 or risk group 3 depending on the lens unit. When classified as risk group 3, this projector is intended for professional use and must be installed by professional installer to ensure safety. See page xviii for risk groups.
- See Page xv for Laser Safety Caution.

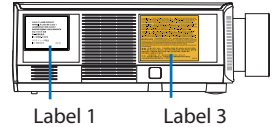

Label 1

Label 3

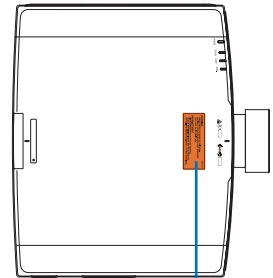

Label 2

 **WARNING**

Power supply



REQUIRED

Use a suitable voltage power supply.

- This projector is designed to be used with a 100–240 V AC, 50/60 Hz power supply. Before using the projector, check that the power supply to which the projector is to be connected meets these requirements.
- Use a power outlet as the projector's power supply. Do not connect the projector directly to electrical light wiring. Doing so is dangerous.



REQUIRED

Handling the power cord

- Please use the power cord supplied with this projector. If the supplied power cord does not satisfy requirements of your country's safety standard, and voltage and current for your region, make sure to use the power cord that conforms to and satisfies them.

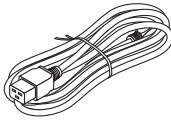

- The power cord you use must be approved by and comply with the safety standards of your country. Please refer to the page [124](#) about the power cord specification.
For selecting an appropriate power cord, please check rated voltage for your region by yourself.



PROHIBITED



**HAZARDOUS
VOLTAGE**

- The power cord included with this projector is exclusively for use with this projector. For safety, do not use it with other devices.
- Handle the power cord with care. Damaging the cord could lead to fire or electric shock.
 - Do not place heavy objects on the cord.
 - Do not place the cord under the projector.
 - Do not cover the cord with a rug, etc.
 - Do not scratch or modify the cord.
 - Do not bend, twist or pull the cord with excessive force.
 - Do not apply heat to the cord.
 Should the cord be damaged (exposed core wires, broken wires, etc.), ask your dealer to replace it.
- Do not touch the power plug should you hear thunder. Doing so could result in electric shock.

 **WARNING**

Installation



PROHIBITED

Do not use in places such as those described below.

- Do not use in places such as those described below. Doing so could lead to fire or electric shock.
 - Shaky tables, inclined surfaces or other unstable places
 - Near heating appliances or places with heavy vibrations
 - Outdoors or humid or dusty places
 - Places exposed to oil smoke or steam
 - Near cooking appliances, humidifiers, etc.
 - Do not use in places such as those described below where the projector could get wet. Doing so could lead to fire or electric shock.
 - Do not use in the rain or snow, on a seashore or waterfront, etc.
 - Do not use in a bathroom or shower room.
 - Do not place vases or potted plants on the projector.
 - Do not place cups, cosmetics or medicines on the projector.
- Should water, etc. get inside the projector, first turn off the projector's power, then unplug the power cord from the power outlet and contact your dealer.



DO NOT WET



UNPLUG THE POWER CORD



CAUTION

Installing suspended from the ceiling

- Consult your dealer for installing the projector on the ceiling. Special skills are required for ceiling installation.
DO NOT perform installation work by people other than installers. Doing so may result in the projector falling and causing injury.
- We are not liable for any accident or/and damage resulting from improper installation or handling, misuse, modification, or natural disasters.
- When installed suspended from the ceiling, etc. do not hang from the projector. The projector could drop and cause injury.
- When installing suspended from the ceiling, use a power outlet that is within reach so the power cord can be easily plugged and unplugged.

On use



PROHIBITED











UNPLUG THE POWER CORD

Do not place objects inside the projector.

- Do not insert or drop metal or combustible objects or other foreign materials into the projector from the vents. Doing so could lead to fire or electric shock. Be particularly careful if there are children in the home. Should a foreign object get inside the projector, first turn off the projector's power, then unplug the power cord from the power outlet and contact your dealer.

 **WARNING**

 <p>UNPLUG THE POWER CORD</p>	<p>Unplug the power cord if the projector malfunctions.</p> <ul style="list-style-type: none"> Should the projector emit smoke or strange odors or sounds, or if the projector has been dropped or the cabinet broken, turn off the projector's power, then unplug the power cord from the power outlet. It may cause not only fire or electric shock but also serious damage to your eyesight or burns. Contact your dealer for repairs. Never try to repair the projector on your own. Doing so is dangerous.
 <p>DO NOT DISASSEMBLE</p>	<p>Do not disassemble the projector.</p> <ul style="list-style-type: none"> Do not remove or open the projector's cabinet. Also, do not modify the projector. There are high voltage areas in the projector. It may cause fire, electric shock, or laser light leakage, resulting in serious damage to your eyesight or burns. Have qualified service personnel perform inspection, adjustments and repairs of the interior.
 <p>PROHIBITED</p>  <p>CAUTION FOR HIGH TEMPERATURE</p>	<p>Do not place objects in front of the lens while the projector is operating.</p> <ul style="list-style-type: none"> Do not leave the lens cap on the lens while the projector is operating. The lens cap could get hot and be warped. Do not place objects in front of the lens that obstruct the light while the projector is operating. The object could get hot and be broken or catch fire. The below pictogram indicated on the cabinet means the precaution for avoiding to place objects in front of the projector lens. 
 <p>PROHIBITED</p>	<p>When cleaning the projector</p> <ul style="list-style-type: none"> Do not use flammable gas sprays to remove dust from the lens, cabinet, etc. Doing so could lead to fire.
 <p>REQUIRED</p>  <p>PROHIBITED</p>	<p>About cable cover (separately sold)</p> <ul style="list-style-type: none"> Be sure to tighten the screws after attaching the cable cover. Failure to do so may cause the cable cover to come off and fall, resulting in injury or damage to the cable cover. Do not put bundled cables in the cable cover. Doing so may damage the power cord, resulting in a fire. Do not hold the cable cover while moving the projector or do not apply excessive force to the cable cover. Doing so may damage the cable cover, resulting in injury.

 **WARNING**



PROHIBITED

Do not use in high security locations.

- Usage of the product must not be accompanied by fatal risks or dangers that, could lead directly to death, personal injury, severe physical damage or other loss, including nuclear reaction control in nuclear facility, medical life support system, and missile launch control in a weapon system.

 **CAUTION**

Power supply



REQUIRED

Connecting the power cord to earth

- This equipment is designed to be used in the condition of the power cord connected to earth. If the power cord is not connected to the earth, it may cause electric shock. Please make sure the power cord is connected to the wall outlet directly and earthed properly.
Do not use a 2-pin plug converter adapter.
- Be sure to connect the projector and the computer (signal source) to the same earth point. If the projector and the computer (signal source) will be connected to different earth points, fluctuations in the earth potential may cause fire or smoke.



REQUIRED









**DO NOT TOUCH
WITH WET
HANDS**







**UNPLUG THE
POWER CORD**

Handling the power cord

- When connecting the power cord to the projector's AC IN terminal, make sure the connector is fully and firmly inserted. Be sure to fix the power cord using the power cord stopper. Loose connection of the power cord could lead to fire or electric shock.
- Do not connect or disconnect the power cord with wet hands. Doing so could result in electric shock.
- When cleaning the projector, for safety purposes unplug the power cord from the power outlet beforehand.
- When moving the projector, first be sure to turn off the power, unplug the power cord from the power outlet and check that all connection cables connecting the projector to other devices have been disconnected.
- When planning not to use the projector for long periods of time, always unplug the power cord from the power outlet.

 CAUTION	
Installation	
 REQUIRED	<p>Securing the lens unit with the fall prevention wire</p> <ul style="list-style-type: none"> • If the projector is going to be suspended from a ceiling or another high place, secure the lens unit using the fall prevention wire (sold separately). If the lens unit is not secured, it may fall down if it comes loose.
On use	
 PROHIBITED	<p>Do not use on networks subject to overvoltage.</p> <ul style="list-style-type: none"> • Connect the projector's Ethernet/HDBaseT port and LAN port to a network for which there is no risk of overvoltage being applied. Overvoltage applied to the Ethernet/HDBaseT or LAN port could result in electric shock.
 REQUIRED	<p>Lens shift, focus and zoom operations</p> <ul style="list-style-type: none"> • When shifting the lens or adjusting the focus or zoom, do so from either behind or the side of the projector. If adjustments are performed from the front, your eyes could be exposed to strong light and get injured. • Keep your hands away from the lens area when performing the lens shift operation. If not, your fingers could get caught in the gap between the cabinet and the lens.
 PROHIBITED	<p>Handling batteries</p> <ul style="list-style-type: none"> • Handle batteries with caution. Failure to do so could lead to fire, injury or contamination of the surroundings. <ul style="list-style-type: none"> - Do not short-circuit or take apart batteries or dispose of them in flames. - Do not use batteries other than those specified. - Do not use new batteries together with old ones. - When inserting batteries, pay attention to the polarities (+ and – directions), and be sure to insert them as indicated. • Contact your dealer or local authorities when disposing of batteries.
 PROHIBITED  CAUTION FOR HIGH TEMPERATURE	<p>About the vents</p> <ul style="list-style-type: none"> • Do not obstruct the projector's vents. Also, do not place such soft objects as paper or cloths underneath the projector. Doing so could lead to fire. Leave sufficient space between the place where the projector is installed and its surroundings. (→ page xxix) • Do not touch the exhaust vent area while projecting or immediately after projecting images. The exhaust vent area may be hot at this time and touching it could cause burns.

 **CAUTION**

 PROHIBITED	<p>Moving the projector</p> <ul style="list-style-type: none"> When moving the projector, do not hold the lens section. The focus ring could turn, causing the projector to drop and resulting in injury. Also, if you put your hand on the gap between the cabinet and the lens, the projector may be damaged, falling and causing injury. When carrying the projector with the lens unit removed, do not touch the mounting area of the lens with your hands. Also, do not put your hand into the recess of the connection terminal. The projector could be damaged or fall down, resulting in injuries. Do not carry the projector by holding the recessed area that is exposed after the filter cover has been removed. Doing so could damage the cabinet, and the projector could fall and cause an injury. When moving the projector with the cable cover attached, do not hold it by the cable cover. The cable cover could come loose and the main unit could fall down, causing injuries.
 REQUIRED	<p>Attaching/detaching the lens</p> <ul style="list-style-type: none"> Turn off the projector and disconnect the power cord before attaching or detaching the lens unit. Failure to do so could result in visual impairment or burns.
 REQUIRED	<p>Avoid locations with extreme temperatures and humidity</p> <ul style="list-style-type: none"> Failure to do so could lead to fire or electric shock or damage to the projector. The usage environment for this projector is as follows: <ul style="list-style-type: none"> The operating temperature: 0°C to 45°C / 32°F to 113°F / humidity: 20 to 80% (without condensation) The storage temperature: -10°C to 50°C / 14°F to 122°F / humidity: 20 to 80% (without condensation)
<p>Inspections and Cleaning</p>	
 REQUIRED	<p>Inspecting the projector and cleaning the inside</p> <ul style="list-style-type: none"> Consult with your dealer about once per year for cleaning of the inside of the projector. Dust could accumulate inside of the projector if it is not cleaned for extended periods of time, leading to fires or malfunction.

Laser Safety Caution

WARNING

CLASS 1 LASER PRODUCT OF IEC 60825-1 THIRD EDITION

- The laser module is equipped in this product. Use of controls or adjustments of procedures other than those specified herein may result in hazardous radiation exposure. Laser energy exposure near aperture may cause burns.
- This product is classified as Class 1 of IEC 60825-1 Third edition 2014-05. Obey the laws and regulations of your country in relation to the installation and management of the device.

For USA

- Complies with 21 CFR 1040.10 and 1040.11 except for conformance as a Risk Group 2 LIP as defined in IEC 62471-5:Ed. 1.0. For more information see Laser Notice No. 57, dated May 8, 2019.

WARNING

- Do not allow to look into the projector beam at any distance from the projector. An adult should supervise the children to prevent exposure risks.
- Check that there is no one looking at the lens, when using the remote control for starting the projector.
- Do not look at the projected light using optical devices(binoculars, telescopes, magnifying glasses, reflectors, etc).
- [WARNING: MOUNT ABOVE THE HEADS OF CHILDREN.]
The use of a ceiling mount is recommended with this product to place it above the eyes of children.

- Outline of laser emitted from the built-in light module:
 - Wave length: 455 nm
 - Maximum power: 176 W (PV800UL-W/PV800UL-B), 154 W (PV710UL-W/PV710UL-B)

Light Module

- A light module containing multiple laser diodes is equipped in the product as the light source.
- These laser diodes are sealed in the light module. No maintenance or service is required for the performance of the light module.
- End user is not allowed to replace the light module.
- Contact qualified distributor for light module replacement and further information.

Laser light radiation range

The figure below shows the maximum radiation range of the laser light.

Horizontal angle (unit: degree)

Lens unit	Zoom	Lens position		
		Right most	Center (Reference value)	Left most
		HR	HC	HL
NP11FL		31.8	31.8	31.8
NP12ZL	Tele	27.4	18.0	27.4
	Wide	34.0	22.9	34.0
NP13ZL	Tele	15.1	9.6	15.1
	Wide	28.3	18.6	28.3
NP14ZL	Tele	9.6	6.0	9.6
	Wide	15.1	9.6	15.1
NP15ZL	Tele	6.4	4.0	6.4
	Wide	9.7	6.1	9.7
NP40ZL	Tele	31.7	23.8	31.7
	Wide	41.0	31.8	41.0
NP41ZL	Tele	13.0	9.4	13.0
	Wide	27.9	20.7	27.9
NP43ZL	Tele	6.8	4.9	6.8
	Wide	13.4	9.7	13.4
NP50ZL	Tele	42.0	32.7	42.0
	Wide	48.2	38.6	48.2

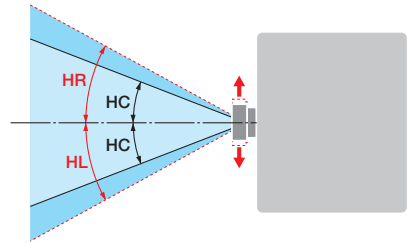

Vertical angle (unit: degree)

Lens unit	Zoom	Lens position		
		Upper most	Center (Reference value)	Lower most
		VU	VC	VD
NP11FL		21.2	21.2	21.2
NP12ZL	Tele	24.0	11.5	13.7
	Wide	30.1	14.8	17.6
NP13ZL	Tele	13.0	6.0	7.2
	Wide	24.8	11.9	14.1
NP14ZL	Tele	8.3	3.8	4.5
	Wide	13.1	6.0	7.2
NP15ZL	Tele	5.5	2.5	3.0
	Wide	8.4	3.8	4.6
NP40ZL	Tele	28.9	15.4	18.3
	Wide	37.8	21.2	24.9
NP41ZL	Tele	11.6	5.9	7.0
	Wide	25.3	13.3	15.8
NP43ZL	Tele	6.1	3.0	3.7
	Wide	12.0	6.1	7.3
NP50ZL	Tele	38.8	21.9	25.7
	Wide	44.9	26.5	30.9

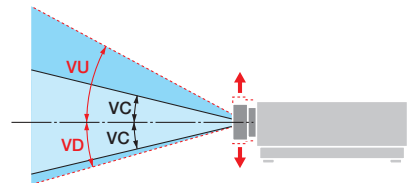

Horizontal angle (unit: degree)

Lens unit	Zoom	
	Tele	Wide
NP44ML	—	55.8

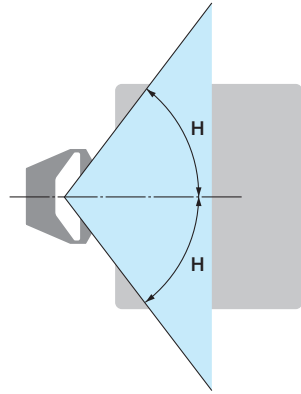

Vertical angle (unit: degree)

Lens unit	Zoom		
	Tele	V1	V2
NP44ML	—	10.7	24.6

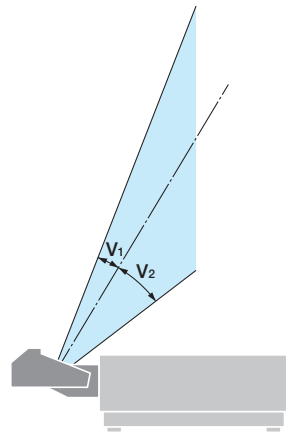

Risk groups

This projector is classified as either IEC/EN 62471-5 First edition risk group 2 or risk group 3 depending on the lens unit.

Risk group 2 (RG2)

 **WARNING**

As with any bright light source, do not stare into the beam, RG2 IEC/EN 62471-5:2015.

Risk group 3 (RG3)

 **WARNING**

RG3 PRODUCT OF IEC/EN 62471-5 FIRST EDITION

- When classified as RG3, this projector is for professional use and must be installed in location where safety is assured. For this reason, be sure to consult your dealer as installation must be performed by a professional installer. Never try to install the projector by yourself. This may result in visual impairment etc.
- No direct exposure to the beam shall be permitted, RG3 IEC/EN 62471-5:2015.
- Do not look into the projector's lens. Serious damage to your eyes could result.
- Operators shall control access to the beam within the hazard distance or install the product at the height that will prevent exposures of spectators' eyes within the hazard distance.
- When turning on the power, operate from the side or rear of the projector (outside the hazard zone). Also, when turning on the power, make sure no one within the projection range is looking at the lens.

• Check before installing the projector

① Lens model name

The lens unit model is listed at one of the locations in in the images below.

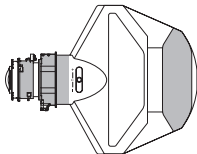
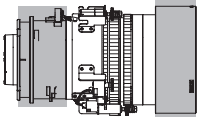
Diagram of NP44ML	Diagram of non-NP44ML models
	

② Combining with Risk group 3 category products

Projector model name	Lens model name
PV800UL-W/PV800UL-B/PV710UL-W/PV710UL-B	NP15ZL, NP43ZL

• Hazard zone

The below figure describes the radiation zone (hazard zone) of light emitted by the projector that is classified as Risk Group 3 (RG3) of IEC/EN 62471-5 First edition 2015.

Overhead view

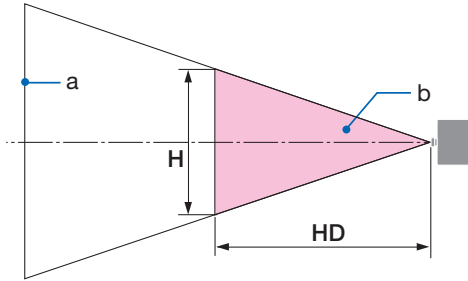

a: Screen / b: Hazard zone

Side view

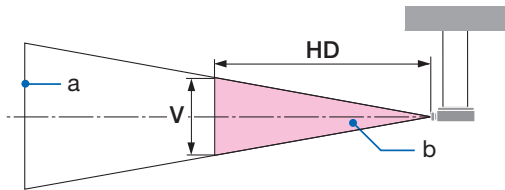

a: Screen / b: Hazard zone

PV800UL-W/PV800UL-B

Lens		Hazard zone (m)		
		HD	H	V
NP15ZL	Wide	1.0	0.25	0.16
	Tele	1.5	0.23	0.15
NP43ZL	Wide	0.7	0.26	0.16
	Tele	1.4	0.24	0.16

PV710UL-W/PV710UL-B

Lens		Hazard zone (m)		
		HD	H	V
NP15ZL	Wide	0.9	0.23	0.14
	Tele	1.3	0.21	0.13
NP43ZL	Wide	0.7	0.23	0.15
	Tele	1.2	0.21	0.13

• About the precautionary zone

By providing a precautionary zone or physical barriers, it is possible to prevent human eyes from entering the hazard zone.

When the manager of the projector (operator) cannot prevent spectators from entering the hazard zone such as in public facilities, it is recommended to secure a space of 1 m or more from the hazard zone as “the precautionary zone” for the safety of the spectators. When installing the projector overhead, it is recommended that the distance between the floor and the hazard zone be at least 3 m in the vertical direction.

In the United States, provide a horizontal distance of 2.5 meters from the hazard zone. When installing the projector overhead, provide a vertical distance of 3 meters from the floor to the hazard zone.

• Installation example considering the precautionary zone

① Floor or desktop installation example

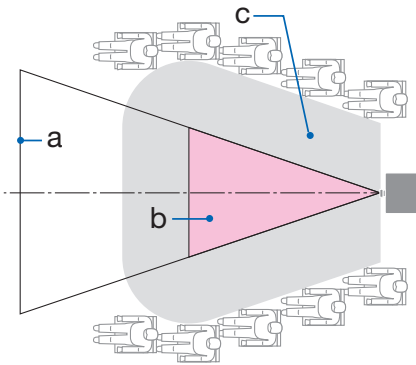

② Ceiling installation example

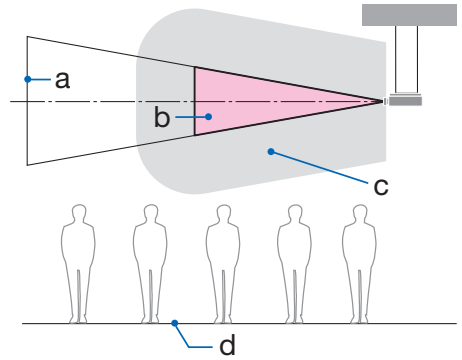

a: Screen / b: Hazard zone / c: Precautionary zone / d: floor



CAUTION

If it is expected that spectators will intrude into the hazard zone when installed on the ceiling, it is necessary to prevent spectators from entering that area.

③ **Example of downward projection installed on the ceiling**

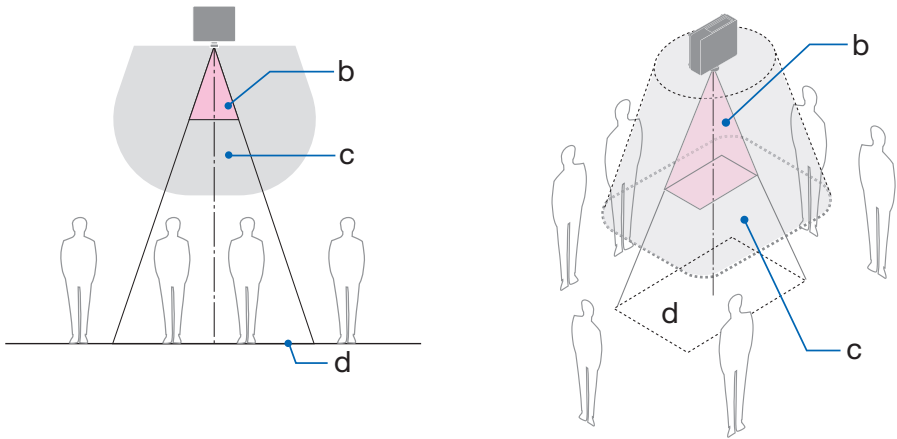

a: Screen / b: Hazard zone / c: Precautionary zone / d: floor

 <p>CAUTION</p>	<p>If the precautionary zone between the floor and the hazard zone cannot be secured, it is necessary to prevent spectators from entering the area around the screen as shown in the figure on the right.</p>
---	---

* If using lens shift, please consider the shift of projected image according to the volume of lens shift. Installation example considering the precautionary zone



Please follow all safety precautions.

Installing the projector

- When planning the layout of the projector, make sure to follow the safety measures listed in the installation manual.
- In order to avoid danger, either install the device within easy reach of a wall outlet or provide a device like a breaker to disconnect power to the projector in emergency.
- Take safety measures to prevent human eyes from entering the hazard zone.
- Select an appropriate lens for the installation location and secure the safety zone set for each lens.
Ensure that appropriate safety measures have been taken when operating the projector, adjusting the light, etc.
- Check whether the appropriate safety zone for the installed lens has been adequately secured. Periodically check the zone and maintain a record of verifications.

The installer or dealer must instruct the manager (operator) of the projector of the following:

- Educate the manager of the projector (operator) about safety before operating the projector.
- Instruct the manager of the projector (operator) to perform inspections (Including safety checks on light emitted by the projector) before powering the projector on.
- Instruct the manager of the projector (operator) to be able to control the projector whenever the projector is powered on in case of an emergency.
- Instruct the manager of the projector (operator) to keep the installation manual, user's manual and inspection records in an easy-to-reach place.
- Instruct them to determine whether the projector conforms to the standards of each country and region.

Cable information

Use shielded cables or cables attached ferrite cores so as not to interfere with radio and television reception.

FCC Information (for USA only)

WARNING

- The Federal Communications Commission does not allow any modifications or changes to the unit EXCEPT those specified by Sharp NEC Display Solutions of America, Inc. in this manual. Failure to comply with this government regulation could void your right to operate this equipment.
- This equipment has been tested and found to comply with the limits for a class A digital device, pursuant to Part 15 of the FCC Rules. These limits are designed to provide reasonable protection against harmful interference when the equipment is operated in a commercial environment. This equipment generates, uses, and can radiate radio frequency energy and, if not installed and used in accordance with the instruction manual, may cause harmful interference to radio communications. Operation of this equipment in a residential area is likely to cause harmful interference in which case the user will be required to correct the interference at his own expense.

Supplier's declaration of conformity

This device complies with Part 15 of the FCC Rules. Operation is subject to the following two conditions.

(1) This device may not cause harmful interference, and (2) this device must accept any interference received, including interference that may cause undesired operation.

U.S.Responsible Party: Sharp NEC Display Solutions of America, Inc.
Address: 3250 Lacey Rd, Ste 500
Downers Grove, IL 60515
Telephone Number: 630-467-3000
Type of Product: Projector
Equipment Classification: Class A Peripheral
Model Number: NP-PV800UL-W/NP-PV800UL-B/NP-PV710UL-W/NP-PV710UL-B



Notice Concerning Electromagnetic Interference (EMI) (For other regions)

WARNING:

Operation of this equipment in a residential environment could cause radio interference.

(For Customers in U.K.)

IMPORTANT

- The wires in this mains lead are coloured in accordance with the following code:

GREEN-AND-YELLOW:	“Earth”
BLUE:	“Neutral”
BROWN:	“Live”

- As the colours of the wires in the mains lead of this apparatus may not correspond with the coloured markings identifying the terminals in your plug proceed as follows:
- The wire which is coloured GREEN-AND-YELLOW must be connected to the terminal in the plug which is marked by the letter **E** or by the safety earth symbol \perp or coloured green or green-and-yellow.
- The wire which is coloured BLUE must be connected to the terminal which is marked with the letter **N** or coloured black.
- The wire which is coloured BROWN must be connected to the terminal which is marked with the letter **L** or coloured red.
- Ensure that your equipment is connected correctly. If you are in any doubt consult a qualified electrician.

“WARNING: THIS APPARATUS MUST BE EARTHED.”



Disposing of your used product



In the European Union

EU-wide legislation as implemented in each Member State requires that used electrical and electronic products carrying the mark (left) must be disposed of separately from normal household waste. This includes the projector or electrical accessory, such as a power cord. When you dispose of such products, please follow the guidance of your local authority and/or ask the shop where you purchased the product.

After collecting the used products, they are reused and recycled in a proper way. This effort will help us reduce the wastes as well as the negative impact to the human health and the environment at the minimum level.

The mark on the electrical and electronic products only applies to the current European Union Member States.

Outside the European Union

If you wish to dispose of used electrical and electronic products outside the European union, please contact your local authority and ask for the correct method of disposal.



For EU: The crossed-out wheeled bin implies that used batteries should not be put to the general household waste! There is a separate collection system for used batteries, to allow proper treatment and recycling in accordance with legislation.

According the EU directive 2006/66/EC, the battery can't be disposed improperly. The battery shall be separated to collect by local service.

(for Germany only)

Machine Noise Information Regulation - 3. GPSGV,

The highest sound pressure level is less than 70 dB (A) in accordance with EN ISO 7779.

Information of the AUDIO OUT mini jack

The AUDIO OUT mini jack does not support earphone/headphone terminal.

Turkish WEEE information relevant for Turkish market

AEEE Yönetmeliğine Uygundur.

Notes on installation and maintenance

Do not install or store in such places as those described below.

- Locations that amplify vibrations and impacts
If installed in places where the vibrations from power sources and the like are conveyed, or in vehicles or on vessels, etc. the projector could be affected by vibrations or shocks that may damage internal parts and lead to malfunction.
- Close to high voltage power lines and power sources
It could disrupt the unit.
- Places where strong magnetic fields are generated
Doing so could lead to malfunction.
- Outdoors and places with humid or dust
Places exposed to oil smoke or steam
Places where corrosive gases are generated
Attached substances such as oil, chemicals and moisture may cause deformation or cracks of the cabinet, corrosion of the metal parts, or malfunction.

To the dealer and the installer

1. To prevent the projector from falling, install it on the ceiling in a way with sufficient strength to withstand the combined weight of the projector and the ceiling mount unit for an extended period of time.
2. When installing the projector on the ceiling, be sure to do so correctly in accordance with the installation manual for the Ceiling Mount Unit. Be sure to use the fixed metal fittings and to tighten the screws securely.
3. To prevent the projector from falling, use fall prevention wires.
 - Use commercially available metal fittings to join the robust part of a building or construction and the security bar of the projector with the fall prevention wires.
 - Use commercially available metal fittings and fall prevention wires that have sufficient strength to withstand the combined weight of the projector and the ceiling mount unit.
 - Slightly slack off the fall prevention wires so as not to put a load on the projector.
 - Refer to the "Part Names of the Projector" for the location of the security bar. (→ page 4)

Cautions for ensuring the projector's performance

- If intense light like laser beams enters from the lens, it could lead to malfunction.
- Consult your dealer before using in places where much cigarette smoke or dust is present.
- When the same still image is projected for a long period of time with a computer, etc. the pattern of the image may remain on the screen after the projection is stopped, but it will disappear after a while. This happens due to the properties of liquid crystal panels, and is not a malfunction. We recommend using a screensaver on the computer side.
- When using the projector at altitudes of about 5500 feet/1600 meters or higher, be sure to set the [FAN MODE] to [HIGH ALTITUDE]. If not, the inside of the projector may get hot, leading to malfunction.
- When the projector is used at high altitudes (places where the atmospheric pressure is low), it may be necessary to replace the optical parts sooner than usual.
- About moving the projector
 - Detach the lens unit once, and be sure to attach the lens cap so as not to scratch the lens. Also, attach a dust protective cap to the projector.
 - Do not subject the projector to vibrations or strong shocks.
The projector could be damaged otherwise.
- Do not use the tilt feet for purposes other than adjusting the projector's tilt.
Improper handling, such as carrying the projector by the tilt feet or using it leaned against a wall, could lead to malfunction.
- Do not touch the surface of the projection lens with bare hands.
Fingerprints or dirt on the surface of the projection lens will be enlarged and projected on the screen. Do not touch the surface of the projection lens.
- Do not unplug the power cord from the projector or the power outlet while projecting. Doing so could cause deterioration of the projector's AC IN terminal or power plug contact. To interrupt the AC power supply while images are being projected, use a breaker, etc.
- About handling of the remote control
 - The remote control will not work if the projector's remote signal sensor or the remote control's signal transmitter is exposed to strong light or if there are obstacles between them that obstruct the signals.
 - Operate the remote control from within 20 meters from the projector, pointing it at the projector's remote signal sensor.
 - Do not drop the remote control or handle it improperly.
 - Do not let water or other liquids get on the remote control. Should the remote control get wet, wipe it off immediately.
 - Avoid using in hot and humid places as far as possible.
 - When planning not to use the remote control for long periods of time, remove both batteries.
- Take measures to prevent external light from shining on the screen.
Make sure only the light from the projector shines on the screen. The less external light on the screen, the higher the contrast and the more beautiful the images.
- About screens
Images will not be clear if there is dirt, scratches, discoloration, etc. on your screen. Handle the screen with care, protecting it from volatile substances, scratches and dirt.

Clearance for Installing the Projector

- When installing the projector, keep sufficient space around it, as described below. If not, the hot exhaust emitted from the projector may be taken back in. Also, make sure no wind from an air-conditioner hits the projector. The projector's heat control system may detect an abnormality (temperature error) and automatically shut off the power.

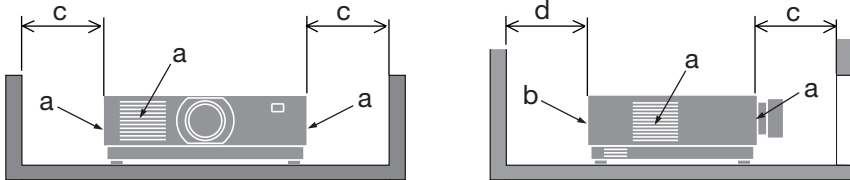

a: Intake vent / b: Exhaust vent / c: 20 cm/8" or greater / d: 30 cm/12" or greater

NOTE:

- In the above figure, it is assumed that there is sufficient space above the projector.
- When using multiple projectors together, provide sufficient space around the projectors for air intake and exhaust. When the intake and exhaust vents are obstructed, the temperature inside the projector will rise and this may result in a malfunction.



About Copyright of original projected pictures:

Please note that using this projector for the purpose of commercial gain or the attraction of public attention in a venue such as a coffee shop or hotel and employing compression or expansion of the screen image with the following functions may raise concern about the infringement of copyrights which are protected by copyright law.

[ASPECT RATIO], [KEYSTONE], Magnifying feature and other similar features.

Power management function

The projector has power management functions. To reduce power consumption, the power management functions (1 and 2) are factory preset as shown below. To control the projector from an external device via a LAN or serial cable connection, use the on-screen menu to change the settings for 1 and 2.

1. STANDBY MODE (Factory preset: NORMAL)

To control the projector from an external device, select [NETWORK STANDBY] or [SLEEP] for [STANDBY MODE]. (→ page 83)

2. AUTO POWER OFF (Factory preset: 1 hour)

To control the projector from an external device, select [OFF] for [AUTO POWER OFF]. (→ page 85)

Registration Information and Software License

- NaViSet, ProAssist, and Virtual Remote are trademarks or registered trademarks of Sharp NEC Display Solutions, Ltd. in Japan, in the United State and other countries.
- Mac is a trademark of Apple Inc. registered in the U.S. and other countries.
- PowerPoint is either a registered trademark or trademark of Microsoft Corporation in the United States and/or other countries.
- The terms HDMI, HDMI High-Definition Multimedia Interface, HDMI Trade Dress and the HDMI Logos are trademarks or registered trademarks of HDMI Licensing Administrator, Inc.



- HDBaseT™ and the HDBaseT Alliance logo are trademarks of the HDBaseT Alliance.



- Trademark PJLink is a trademark applied for trademark rights in Japan, the United States of America and other countries and areas.
- Blu-ray is a trademark of Blu-ray Disc Association.
- CRESTRON and CRESTRON ROOMVIEW are trademarks or registered trademarks of Crestron Electronics, Inc. in the United States and other countries.
- Extron and XTP are registered trademarks of RGB Systems, Inc. in the United States.
- Ethernet is either a registered trademark or trademark of FUJIFILM Business Innovation Corp.
- Other product and company names mentioned in this manual may be the trademarks or registered trademarks of their respective holders.
- Virtual Remote Tool uses WinI2C/DDC library, © Nicomsoft Ltd.
- GPL/LGPL Software Licenses

The product includes software licensed under GNU General Public License (GPL), GNU Lesser General Public License (LGPL), and others.

For more information on each software, visit our web site.

https://www.sharp-nec-displays.com/dl/en/pj_manual/lineup.html

1. Check the product overview, supplied items and part names

1-1. Introduction to the Projector

This section introduces you to your new projector and describes the features and controls.

- **Liquid crystal type high brightness/high resolution projector**

This projector has a display resolution of 1920 dots × 1200 lines (WUXGA) and an aspect ratio of 16:10.

Model	Brightness
PV800UL-W/PV800UL-B	8000 lm
PV710UL-W/PV710UL-B	7100 lm

- **A long-life laser diode is equipped in the light module**

The product can be operated at low cost because the laser light source can be used for a long time without requiring replacement or maintenance.

- **Wide range of optional lenses selectable according to the place of installation**

This projector supports 10 types of optional lenses, providing a selection of lenses adapted to a variety of places of installation and projection methods.

Note that no lens is mounted upon shipment from the factory. Please purchase optional lenses separately.

- **Motorized lens control function for easily adjusting the position of the projected image**

The position of the projected image (lens shift) can be adjusted by buttons either on the control panel on the back of the cabinet or the remote control.

- **360 degree free projection**

This projector can be installed universally in every angle.

For controlling fine inclination, use the tilt foot. Install an appropriate metal and a stand that has enough strength to support the projector for controlling the installation angle.

- **Seamless switch function for smoother screen changes when switching the signal**

When the input connector is switched, the image displayed before switching is held so that that the new image can be switched to without a break due to absence of a signal.

- **Supports wired LAN**

Equips the LAN and Ethernet/HDBaseT (RJ-45) ports. Utilizing a wired LAN connected with these ports, it enables to control the projector by a computer.

1. Check the product overview, supplied items and part names

- **Convenient software applications**

Compatible with our software applications (NaViSet Administrator 2, ProAssist, Virtual Remote Tool, etc.). The projector can be controlled from a computer connected via a wired LAN.

- NaViSet Administrator 2

You can monitor the status of the projector and control a variety of functions.

- ProAssist

You can control the projector and correct any distortions when projecting onto uniquely shaped screens, like circular, spherical, or other such surfaces.

- Virtual Remote Tool

A virtual remote control is displayed on the computer screen to perform simple controls such as turning the projector on/off, switching signals, etc. It is also possible to change the background logo of the projector.

Please visit our web site for downloading each software.

URL: <https://www.sharp-nec-displays.com/dl/en/index.html>

- **CRESTRON ROOMVIEW and Extron XTP compatibility**

The projector supports CRESTRON ROOMVIEW and Extron XTP, allowing multiple devices connected in the network to be managed and controlled from a computer. Moreover, it enables to output and control image via an Extron XTP transmitter connected with the projector.

- **0.16 W (100-130 V AC)/0.32 W (200-240 V AC) in standby condition with energy saving technology**

Selecting [NORMAL] for [STANDBY MODE] from the menu can put the projector in power-saving mode.

NORMAL: 0.16 W (100-130 V AC)/0.32 W (200-240 V AC)

NETWORK STANDBY: 1.6 W (100-130 V AC)/1.8 W (200-240 V AC)

- **[LIGHT MODE] and “Carbon Meter” display**

Three [LIGHT MODE] options can be selected according to the purpose of use. [LIGHT ADJUST] can also be used to reduce output power and control energy consumption. The energy-saving effect from that time will be factored into the amount of reduced CO₂ emissions and displayed in the confirmation message when turning the power off as well as the [INFO.] area in the on-screen menu (CARBON METER)

1. Check the product overview, supplied items and part names

1-2. What's in the Box?

Make sure your box contains everything listed. If any pieces are missing, contact your dealer. Please save the original box and packing materials if you ever need to ship your projector.

Projector

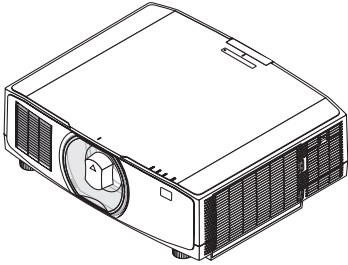

Dust cap for lens
(24F53241)

* The projector is shipped without a lens. For the types of lens and throw distances, see page 112.

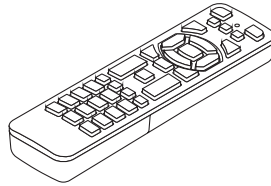

Remote control
(7N901322)

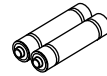

AAA alkaline batteries (x2)

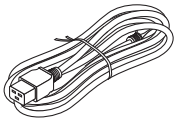

Power cord

Plug type	
For USA	For EU
7N080242	7N080028

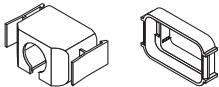

Power cord stopper
(24F53221/24F53232)



Strap
(24F54153)



Lens theft prevention screw
(24V00941)

Documents

- Important Information (TINS-0003VW01/TINS-0004VW01) (For North America and Taiwan: TINS-0004VW01)
- Quick Setup Guide (TINS-0005VW01)
- Security Sticker (Use this sticker when security password is set on.)

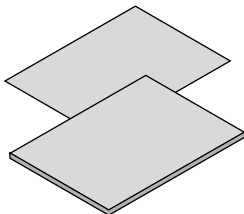

For North America only

Limited warranty

For customers in Europe

You will find our current valid Guarantee Policy on our Web Site:

<https://www.sharpedisplays.eu>

1-3. Part Names of the Projector

Front

The lens is sold separately. The description below is for when the NP13ZL lens is mounted.

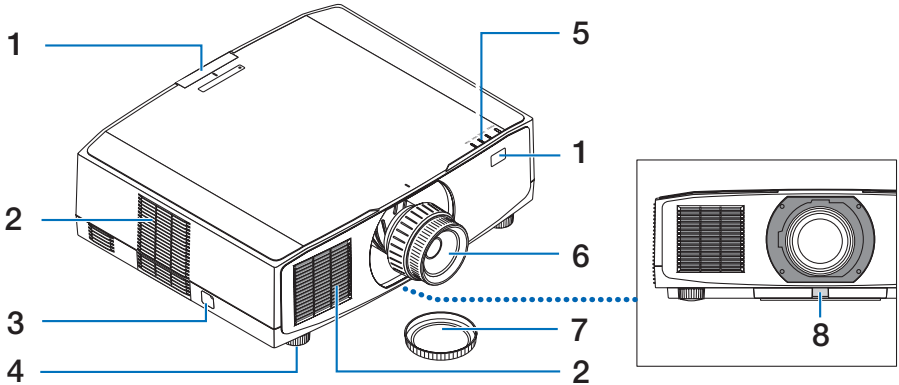

1. Remote Sensor

This part receives signals from the remote control. There are two locations on the front and back of the projector.

2. Intake vent

Takes in outside air to cool the unit.

3. Security Bar

Attach an anti-theft device. The security bar accepts security wires or chains up to 0.18 inch/4.6 mm in diameter.

4. Adjustable Tilt Foot

Rotate the tilt feet to adjust the left/right orientation.

5. Indicator Section

The indicator light turns on or blinks to relay the status of the projector (Power ON/ Standby/etc.)

6. Lens

Images are projected from here. (Lens unit sold separately.)

7. Lens Cap

(The optional lens is shipped with the lens cap.)

8. Lens Release Button

Use this to remove the lens unit.

1. Check the product overview, supplied items and part names

Rear

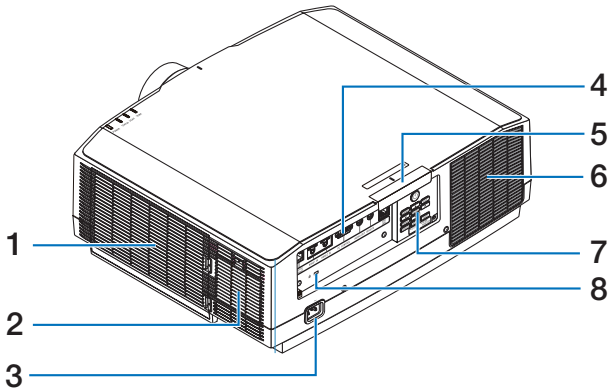

1. Intake vent/Filter

Takes in outside air to cool the unit. The filter prevents dust and dirt from entering inside.

2. Intake vent

Takes in outside air to cool the unit.

3. AC IN Terminal

Connect the supplied power cord's three-pin plug here, and plug the other end into an active wall outlet.

4. Terminals

Connect the cables for the various audio and video signals.

5. Remote Sensor

This part receives signals from the remote control. There are two locations on the front and back of the projector.

6. Exhaust vent

Heated air is exhausted from here.

7. Controls

The projector's power can be turned ON/OFF, and the signal for the projected image can be switched here.

8. Security Slot (🔒)*

This is used when attaching an anti-theft cable.

* Security and theft protection lock compatible with Kensington security cables/equipment. For products, visit Kensington's website.

Controls/Indicators

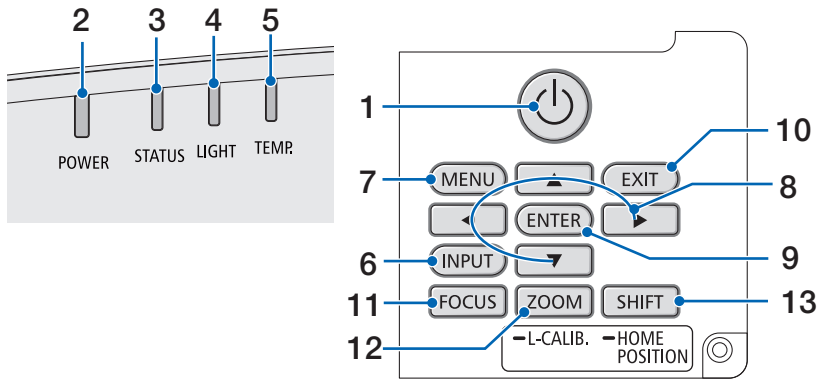

1. (POWER) Button

Switches between projector's power on and standby.

When turning off the power (standby), pressing the button once will bring up a confirmation message on the screen, so press the button one more time.

2. POWER Indicator

Indicates the projector's power state. The indicator lights up in blue when the power is on. Depending on the state of power, it will light up or blink in either green or orange when power is off. Refer to the "Indicator Message" section for details. (→ page 132)

3. STATUS Indicator

This lights up or blinks when an operation button is pressed while the unit is in key lock mode, while the lens is calibrating, etc. Refer to the "Indicator Message" section for details. (→ page 132)

4. LIGHT Indicator

Indicates the state of the light source.

5. TEMP. Indicator

Indicates high temperatures around the projector.



6. INPUT Button

Selects the input signal. Pressing it quickly will display the input selection screen. Pressing it for one second or longer will begin a series of automatic checks in the order of HDMI1 → HDMI2 → HDBaseT, and if an input signal is detected then that signal will be projected.

7. MENU Button

Displays the on-screen menu for various settings and adjustments.

8. / Volume Buttons

- When the on-screen menu is displayed, use the  buttons to select the item that you wish to set or adjust.
- Changes the pattern when the test pattern is displayed.
- When the on-screen menu is not displayed, use the  buttons to adjust the sound output from the projector.

9. ENTER Button

Moves to the next menu when the on-screen menu is displayed. Confirms the item when the confirmation message is displayed.

10. EXIT Button

Returns to the menu on the previous level when the on-screen menu is displayed. Closes the menu when a cursor appears in the main menu. Cancels the operation when the confirmation message is displayed.

11. FOCUS Button

Applicable lens unit: NP40ZL/NP41ZL/NP43ZL/NP44ML/NP50ZL

Open the focus adjustment screen and focus the projected image.

12. ZOOM/L-CALIB. Button

Applicable lens unit: NP40ZL/NP41ZL/NP43ZL/NP44ML/NP50ZL

- Short press to open the zoom adjustment screen. Finely adjust the size of the projected image.
- Long press (two seconds or longer) to correct the adjustment range of the attached lens unit (calibration).

13. SHIFT/HOME POSITION Button

- Short press to display the lens shift screen. Adjust them using the ▼▲◀▶ buttons.
- Long press (2 seconds or longer) to return the lens shift adjustment to its initial position.

1. Check the product overview, supplied items and part names

Terminal Panel Features

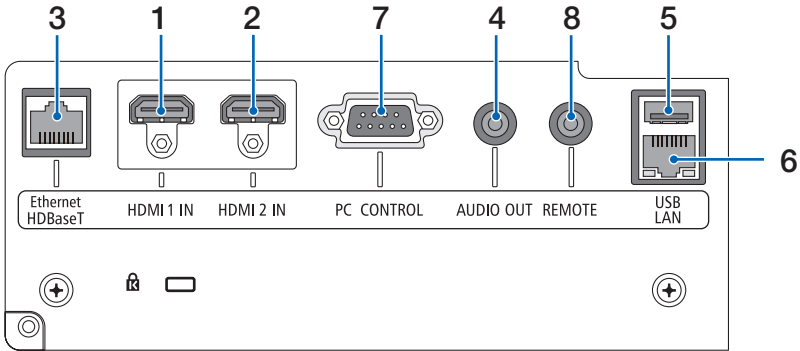

1. HDMI 1 IN Terminal (Type A)

Connects to the output terminals of a computer, blu-ray player, etc.

2. HDMI 2 IN Terminal (Type A)

Connects to the output terminals of a computer, blu-ray player, etc.

3. Ethernet/HDBaseT Port (RJ-45)

Connects to a commercially available HD-BaseT compatible transmission devices.

4. AUDIO OUT Mini Jack (Stereo Mini)

Outputs the audio signal corresponding to the image projected from the projector.

5. USB Port (Type A)

Use a 5 V / 1.4 A power supply.

6. LAN Port (RJ-45)

Connects the unit to a wired LAN.

7. PC CONTROL Port (D-Sub 9 Pin)

Use this port to connect a PC or control system. This enables you to control the projector using serial communication protocol.

8. REMOTE Terminal (Stereo Mini)

Use this terminal for wired remote control of the projector.

NOTE:

- When a remote control cable is connected to the REMOTE terminal, infrared remote control operations cannot be performed.
- When [HDBaseT] is selected in the [REMOTE SENSOR] and the projector is connected to a commercially-available transmission device that supports HDBaseT, remote control operations in infra-red cannot be carried out if transmission of remote control signals has been set up in the transmission device. However, remote control using infrared rays can be carried out when the power supply of the transmission device is switched off.

1. Check the product overview, supplied items and part names

1-4. Part Names of the Remote Control

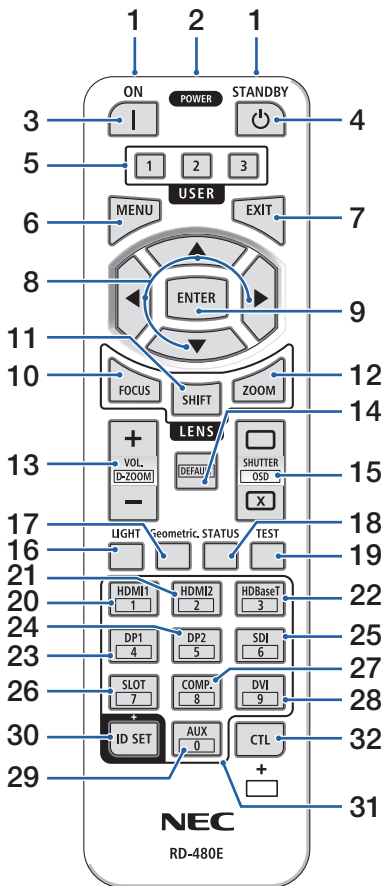

1. Infrared Transmitter

Remote control signals are sent via infrared signal. Point the remote control at the remote control receiver on the projector.

2. Remote Jack

Connect a commercially available remote cable here for wired operation.

3. POWER ON Button (|)

Turns power ON when in sleep or standby mode.

4. POWER STANDBY Button (⏻)

Pressing the button once will display the shutdown confirmation message. Press the POWER STANDBY (or ENTER) button once more to power down the projector.

5. USER 1/2/3 Button

The following functions are set as follows.

USER 1: (Not available on this series of projectors.)

USER 2: AV-MUTE

Turns off the image and sound for a short period of time.

USER 3: FREEZE

Changes the projected video to a still image.

6. MENU Button

Displays the on-screen menu for various settings and adjustments.

7. EXIT Button

Returns to the menu on the previous level when the on-screen menu is displayed. Closes the menu when a cursor appears in the main menu. Cancels the operation when the confirmation message is displayed.

1. Check the product overview, supplied items and part names

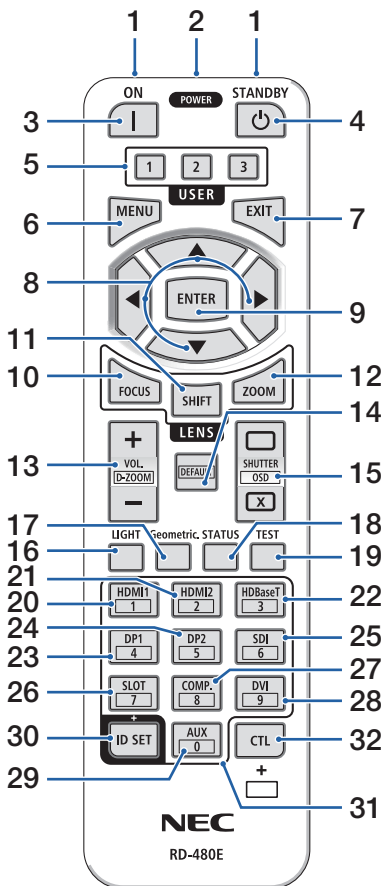

8. ▲▼◀▶ Button

- When the on-screen menu is displayed, use the ▼▲◀▶ buttons to select the item that you wish to set or adjust.
- Changes the pattern when the test pattern is displayed.

9. ENTER Button

Moves to the next menu when the on-screen menu is displayed. Confirms the item when the confirmation message is displayed.

10. FOCUS Button

Applicable lens unit: NP40ZL/NP41ZL/NP43ZL/ NP44ML/NP50ZL

Opens the focus adjustment screen. Adjust the focus (of the lens) with the ◀ / ▶ buttons.

11. SHIFT Button

The lens shift adjustment screen will be displayed. Use the ▼▲◀▶ buttons to adjust the lens position.

12. ZOOM Button

Applicable lens unit: NP40ZL/NP41ZL/NP43ZL/ NP44ML/NP50ZL

Opens the zoom adjustment screen. Adjust zoom with the ◀ / ▶ buttons.

13. VOL./D-ZOOM (+)(-) Button

Adjusts the volume level of the audio output terminals. Simultaneously pressing the CTL button will expand or shrink the image (return to the original state).

14. DEFAULT Button

(Not available on this series of projectors. For future expansion)

1. Check the product overview, supplied items and part names

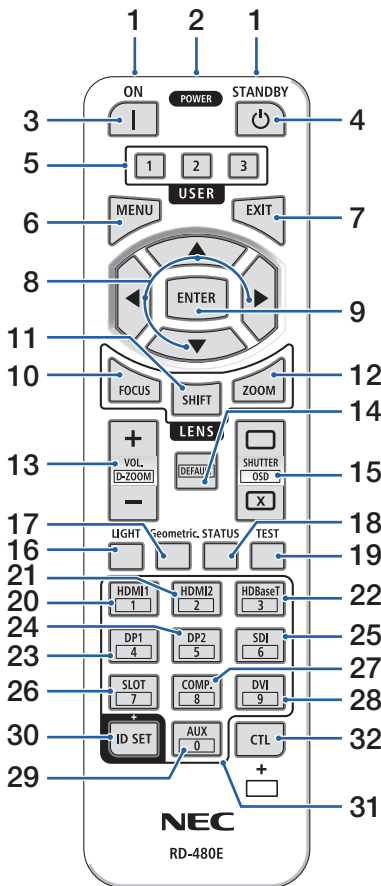

15. SHUTTER/OSD OPEN (□)/CLOSE (X) Button

Press the CLOSE button to turn off the light source and temporarily stop projection. Press the OPEN button to resume. Simultaneously press the CTL and CLOSE buttons to close the on-screen display (On-Screen Mute). Simultaneously press the CTL and OPEN buttons to go back.

16. LIGHT Button

Displays the light mode screen.

17. Geometric. Button

Displays [GEOMETRIC CORRECTION] from the on-screen menu. Use it to adjust distortions in projected images.

18. STATUS Button

Displays [USAGE TIME] of [INFO.] from the on-screen menu.

19. TEST Button

Projects a test pattern.

20. HDMI1 Button

Selects the HDMI1 input.

21. HDMI2 Button

Selects the HDMI2 input.

22. HDBaseT Button

Selects HDBaseT.

23. DP1 Button

(Not available on this series of projectors.)

24. DP2 Button

(Not available on this series of projectors.)

25. SDI Button

(Not available on this series of projectors.)

26. SLOT Button

(Not available on this series of projectors.)

27. COMP. Button

(Not available on this series of projectors.)

1. Check the product overview, supplied items and part names

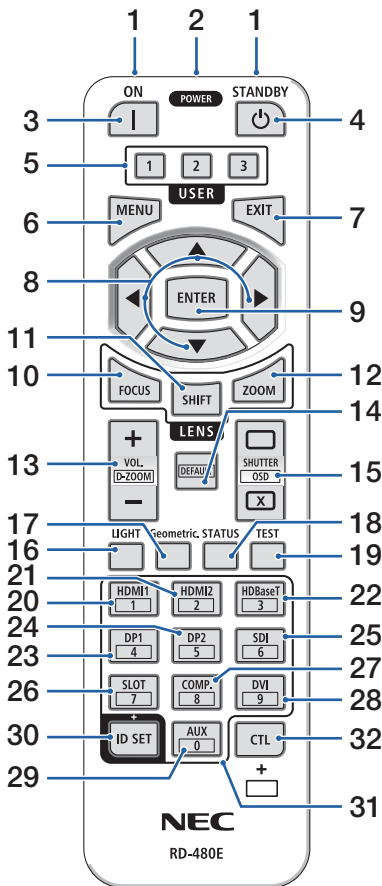

28. DVI Button

(Not available on this series of projectors.)

29. AUX Button

(Not available on this series of projectors. For future expansion)

30. ID SET Button

Used to set the control ID when performing individual operations on multiple projectors using the remote control.

31. Numeric Keypad Button

Used to input the control ID when performing individual operations on multiple projectors using the remote control (set the control ID). Pressing the 0 button while holding down the ID SET button will remove any control ID settings.

32. CTL Button

This is a multipurpose button for combined use with other buttons.

Battery Installation

1. Press the catch and remove the battery cover.

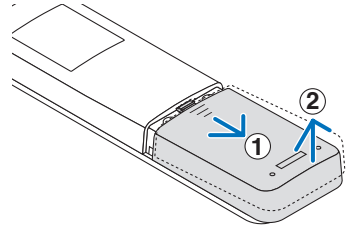

2. Install new ones (AAA). Ensure that you have the batteries' polarity (+/-) aligned correctly.

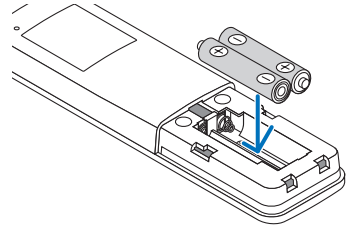

3. Slip the cover back over the batteries until it snaps into place.

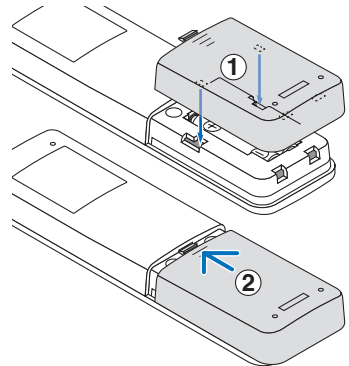

NOTE:

- Do not mix different types of batteries or new and old batteries.
-

Remote Control Precautions

- Handle the remote control carefully.
- If the remote control gets wet, wipe it dry immediately.
- Avoid excessive heat and humidity.
- Do not short, heat, or take apart batteries.
- Do not throw batteries into fire.
- If you will not be using the remote control for a long time, remove the batteries.
- Ensure that you have the batteries' polarity (+/-) aligned correctly.
- Do not use new and old batteries together, or use different types of batteries together.
- Dispose of used batteries according to your local regulations.
- Please note that if multiple projectors are installed nearby, other projectors may unintentionally light up when you turn on the power using the remote control.

1. Check the product overview, supplied items and part names

Operating Range for Wireless Remote Control

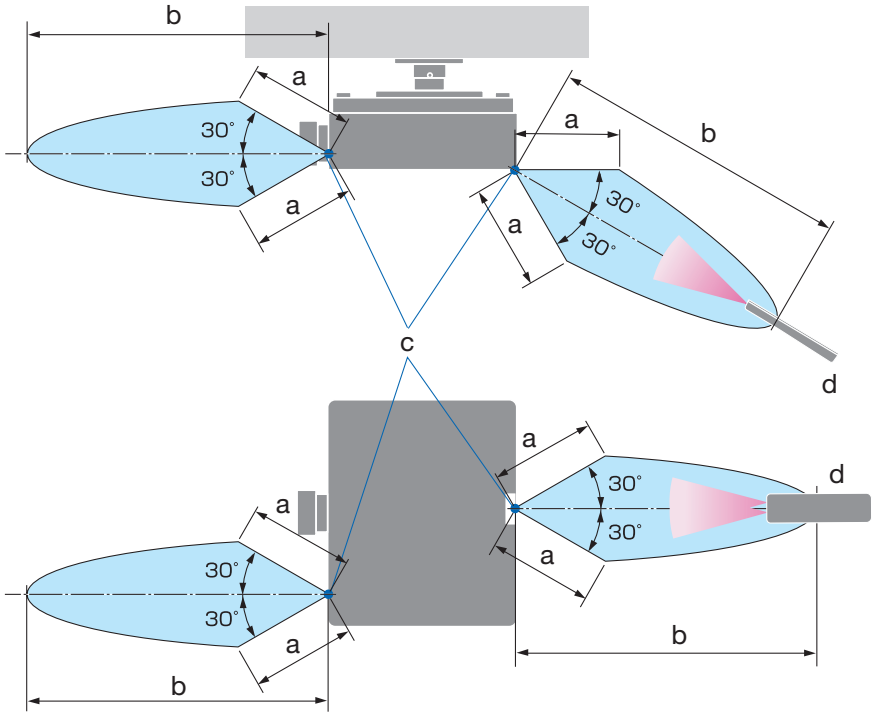

a: 7 m/276" / b: 20 m/787" / c: Remote sensor on projector cabinet / d: Remote control

- The projector will not respond if there are objects between the remote control and the sensor, or if strong light falls on the sensor. Weak batteries will also prevent the remote control from properly operating the projector.

1. Check the product overview, supplied items and part names

Using the Remote Control in Wired Operation

Connect one end of the remote cable to the REMOTE terminal and the other end to the remote jack on the remote control.

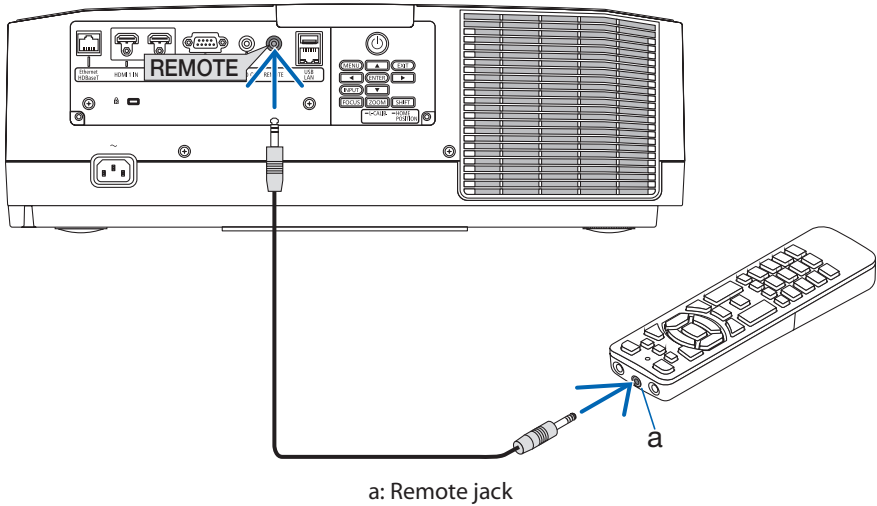

a: Remote jack

NOTE:

- When a remote cable is inserted into the REMOTE terminal, the remote control does not work for infrared wireless communication.
- Power will not be supplied to the remote control by the projector via the REMOTE jack. Battery is needed when the remote control is used in wired operation.

2. Projecting an Image (Basic Operation)

This section describes how to turn on the projector and to project a picture onto the screen.

2-1. Flow of Projecting an Image

Step 1

- **Connecting your computer / Connecting the power cord** (→ [page 17](#))



Step 2

- **Turning on the projector** (→ [page 19](#))



Step 3

- **Selecting a source** (→ [page 22](#))



Step 4

- **Adjusting the picture size and position** (→ [page 24](#))



Step 5

- **Adjusting a picture and sound** (→ [page 34](#))



Step 6

- **Making a presentation**



Step 7

- **Turning off the projector** (→ [page 35](#))



Step 8

- **After use** (→ [page 36](#))

2-2. Connecting Your Computer/Connecting the Power Cord

1. Connect your computer to the projector.

This section will show you a basic connection to a computer.

Connect a commercially available HDMI cable between the computer's HDMI output connector and the projector's HDMI 1 IN or HDMI 2 IN connector.

2. Connect the supplied power cord to the projector.

First connect the supplied power cord's three-pin plug to the AC IN terminal of the projector, and then connect another plug of the supplied power cord directly in the wall outlet. Do not use any plug converter.



CAUTION:

- This equipment is designed to be used in the condition of the power cord connected to earth. If the power cord is not connected to the earth, it may cause electric shock. Please make sure the power cord is connected to the wall outlet directly and earthed properly. Do not use a 2-pin plug converter adapter.
- Be sure to connect the projector and the computer (signal source) to the same earth point. If the projector and the computer (signal source) will be connected to different earth points, fluctuations in the earth potential may cause fire or smoke.
- To prevent the power cord from coming loose, make sure that all the prongs of the power cord plug are fully inserted into the AC IN terminal of the projector before using the power cord stopper. A loose contact of the power cord may cause a fire or electric shock.

Upon connecting the power cable, the POWER indicator of the projector will light.

2. Projecting an Image (Basic Operation)

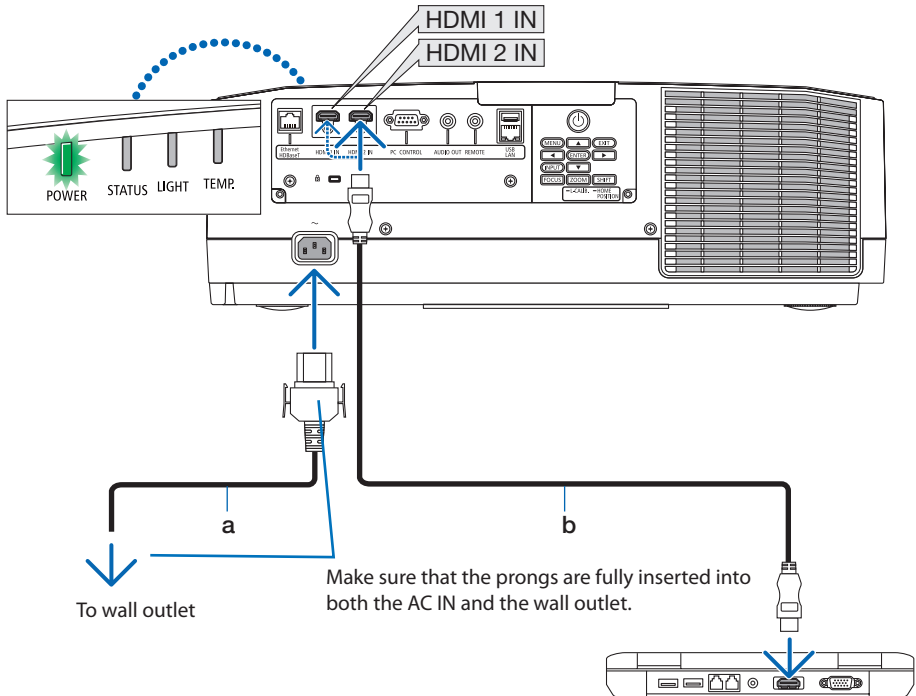

a: Power cord (supplied) / b: HDMI cable (not supplied)

- Use a certified High Speed HDMI® Cable.
- To prevent the power cord from accidentally removing from the AC IN of the projector, use the power cord stopper. Insert the power cord plug to the AC IN terminal until the power cord stopper is fastened completely and click sound is heard. (→ page 96)

CAUTION:

Parts of the projector may become temporarily heated if the projector is turned off with the POWER button or if the AC power supply is disconnected during normal projector operation. Use caution when picking up the projector.

NOTE:

- If you pull on the power supply cord while the connector is fixed, the main unit may fall down and be damaged.

2-3. Turning on the Projector

WARNING

The projector produces a strong light. When turning on the power, operate from the side or rear of the projector (outside the hazard zone). Also, when turning on the power, make sure no one within the projection range is looking at the lens.

1. Remove the lens cap.

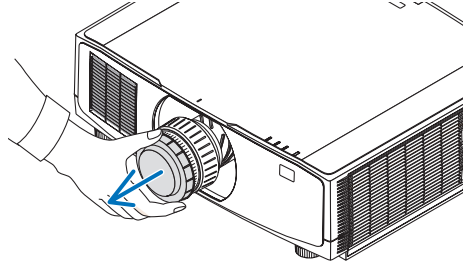

2. Press the (POWER) button on the projector cabinet or the POWER ON button on the remote control.

The POWER indicator lit in green will start to blink in blue. After that, the image will be projected onto the screen.

TIP:

- When the message "PROJECTOR IS LOCKED! ENTER YOUR PASSWORD." is displayed, it means that the [SECURITY] feature is turned on.

After you turn on your projector, ensure that the computer or video source is turned on.

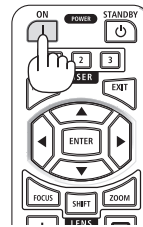

NOTE:

- A blue screen (blue background) is displayed when no signal is being input (by factory default menu settings).

Performing Lens Calibration

After mounting the separately available lens unit or replacing a lens unit, perform [LENS CALIBRATION] by holding to press ZOOM/L-CALIB. button on the cabinet over two seconds.

Calibration corrects the adjustable zoom, shift, and focus range. If calibration is not performed, you may not be able to get the best focus and zoom even if you adjust the focus and zoom for the lens.

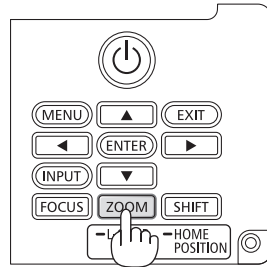

Note on Startup screen (Menu Language Select screen)

When you first turn on the projector, you will get the Startup menu. This menu gives you the opportunity to select one of the 30 menu languages.

To select a menu language, follow these steps:

1. Use the ▲, ▼, ◀ or ▶ button to select one of the 30 languages from the menu.

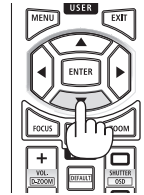

2. Press the ENTER button to execute the selection.

After this has been done, you can proceed to the menu operation.

If you want, you can select the menu language later.

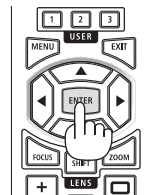

NOTE:

- Keep the lens cap off the lens while the projector's power is on. If the lens cap is on, it could be warped due to high temperature.
- If the STATUS indicator lights orange with the power button pressed, the projector will not be turned on since the [CONTROL PANEL LOCK] has been [ON]. Cancel the lock by turning it off.
- While the POWER indicator is blinking blue in short cycles, the power cannot be turned off by using the power button.

2-4. Selecting a Source

Selecting the computer or video source

NOTE:

- Turn on the computer or video source equipment connected to the projector.

Detecting the Signal Automatically

Press the INPUT button for 1 second or longer. The projector will search for the available input source and display it. The input source will change as follows:

HDMI1 → HDMI2 → HDBaseT → HDMI1 → ...

- Press it briefly to display the [INPUT] screen.

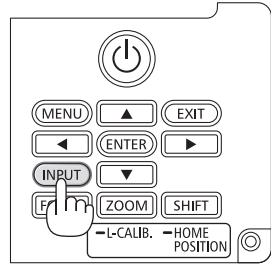
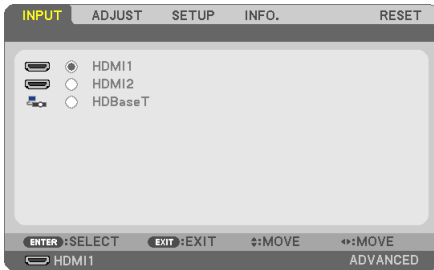

- Press the ▼/▲ buttons to match the target input terminal and then press the ENTER button to switch the input. To delete the menu display in the [INPUT] screen, press the MENU or EXIT button.

TIP:

- If no input signal is present, the input will be skipped.

Using the Remote Control

Press any one of the HDMI1, HDMI2, or HDBaseT button.

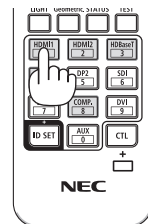

Selecting Default Source

You can set a source as the default source so that it will be displayed each time the projector is turned on.

1. Press the MENU button.

The menu will be displayed.

2. Press the ► button to select [SETUP] and press the ▼ button or the ENTER button to select [GENERAL].

3. Press the ► button to select [OPTIONS(2)] and press the ▼ button or the ENTER button.

4. Press the ▼ button 4 times to select [DEFAULT INPUT SELECT] and press the ENTER button.

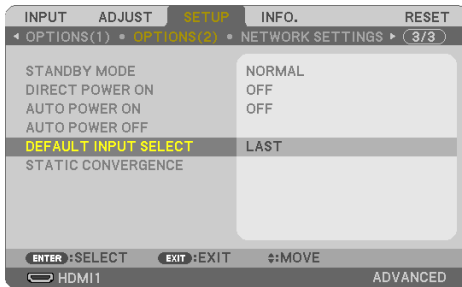

The [DEFAULT INPUT SELECT] screen will be displayed.

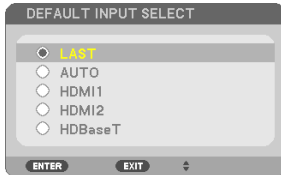

5. Select a source as the default source, and press the ENTER button.

6. Press the EXIT button a few times to close the menu.

7. Restart the projector.

The source you selected in step 5 will be projected.

2-5. Adjusting the Picture Size and Position

Use the lens shift, the adjustable tilt foot, the zoom and the focus to adjust the picture size and position.

In this chapter drawings and cables are omitted for clarity.

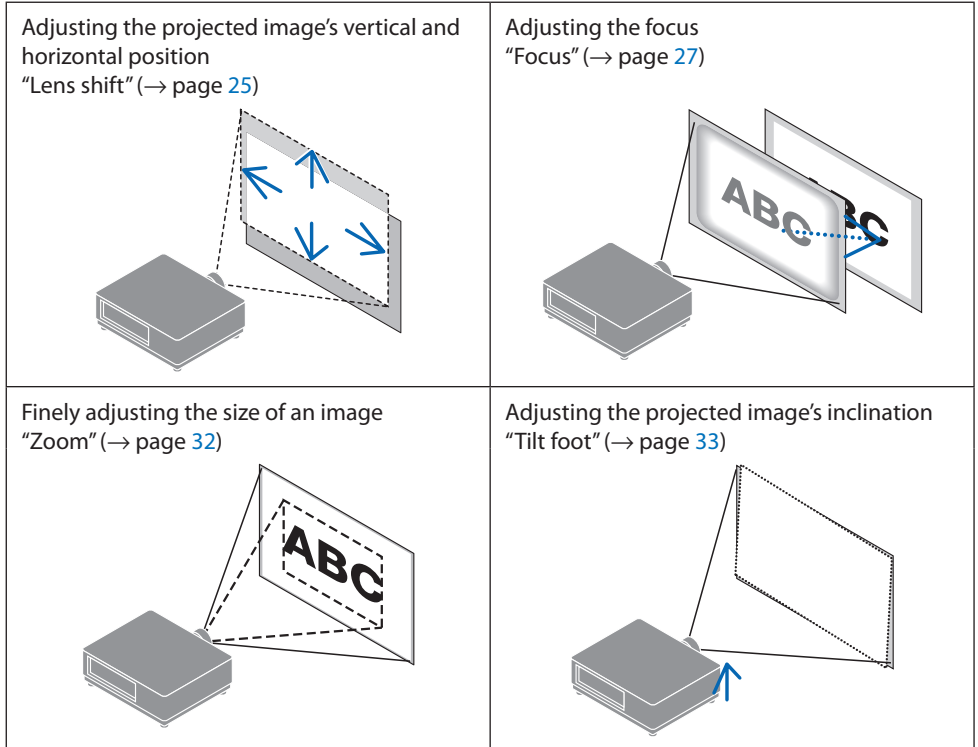

Adjusting the vertical position of a projected image (Lens shift)

CAUTION

- Perform the adjustment from behind or from the side of the projector. If adjustments are performed from the front, your eyes could be exposed to strong light and get injured.
- Keep hands away from the lens mounting portion while performing a lens shift. Failure to do so could result in fingers being pinched by the moving lens.

1. Press either **SHIFT/HOME POSITION** button on the cabinet or **SHIFT** button on the remote control.

The [LENS SHIFT] screen will be displayed.

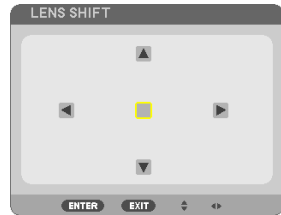

2. Press the **▼▲◀▶** buttons to move the projected image.

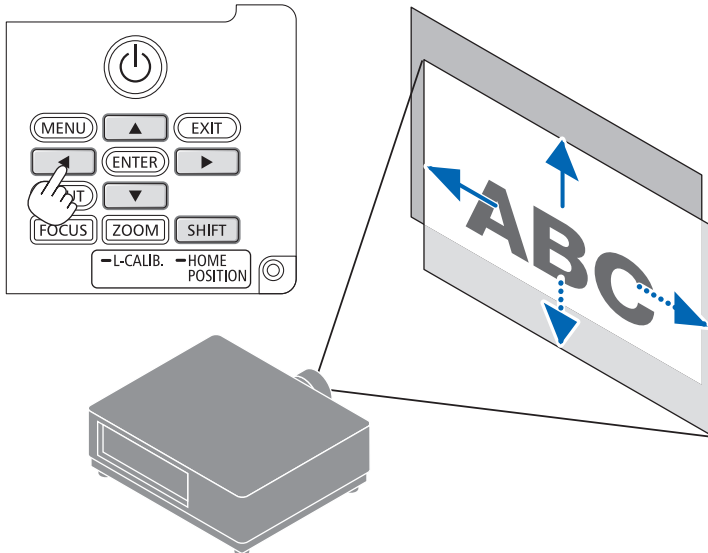

To set back the lens to the home position

Press and hold the **SHIFT/HOME POSITION** button over 2 seconds. The lens mounted on the projector goes back to the home position. (roughly to the center position)

2. Projecting an Image (Basic Operation)

NOTE:

- If the lens is shifted to the maximum in the diagonal direction, the screen peripheral area will be dark or shaded.
- Use NP11FL at the home position. If necessary, fine-adjust the position of the projected image using the lens shift function.
- Fix the NP50ZL to the projector using the supplied support kit. Loosen the bolts of the support kit, you can adjust the lens shift.
- Fix the NP44ML to the projector using the separately sold support kit (NP01LK). Lens shift is not available for the NP44ML.

TIP:

- The figure below shows the lens shift adjustment range (projection method: Desktop/Front) of the NP41ZL lens unit.

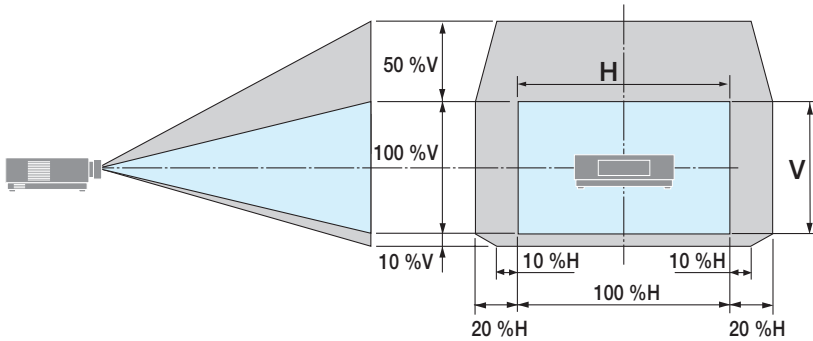

Description of symbols: V indicates vertical (height of the projected image), H indicates horizontal (width of the projected image).

Focus

Recommend to perform the focus adjustment after leaving the projector under the state the TEST PATTERN has been projected for over 30 minutes.

Applicable lens: NP12ZL/NP13ZL/NP14ZL/NP15ZL (Manual focus)

Use the focus ring to obtain the best focus.

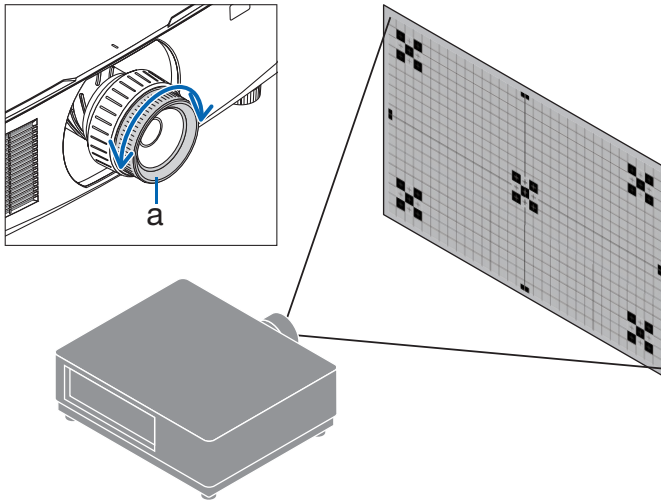

a: Focus ring

Applicable lens: NP11FL (Manual focus)

With the NP11FL lens, adjust the focus and picture distortion.

Preparations:

Press and hold the SHIFT/HOME POSITION button on the cabinet longer than 2 seconds for shifting back the lens to the home position.

1. Turn the distortion ring to the left edge.

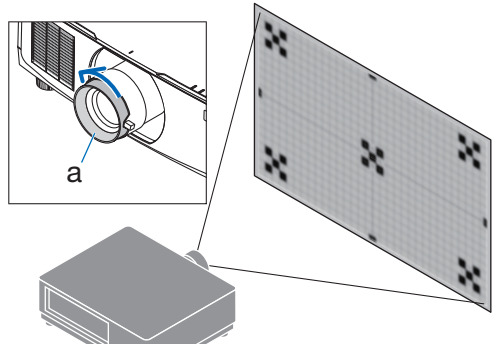

a: Distortion ring

2. Turn the focus lever clockwise and counterclockwise to adjust the focus at the center of the screen.

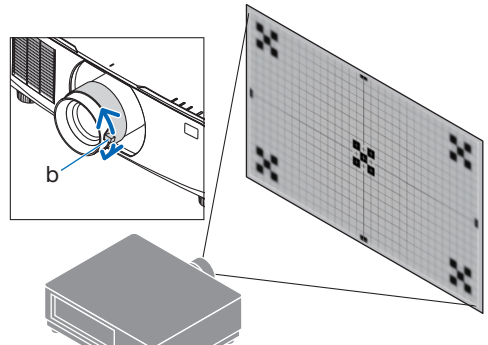

b: Focus lever

3. Use the distortion ring to correct the screen's distortion.

(This also brings the screen peripheral area into focus.)

4. Use the focus lever to adjust the screen's overall focus.

* If the focus at the center of the screen is off, turn the distortion ring a little counterclockwise. The focus at the center of the screen can now be adjusted with the focus lever.

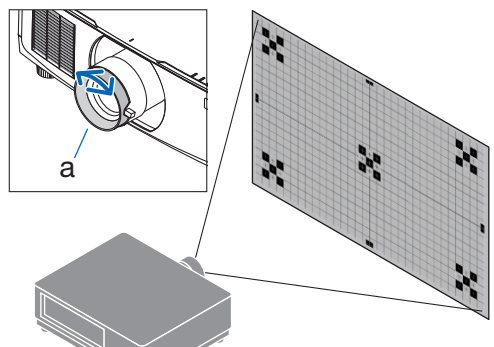

a: Distortion ring

Applicable lens: NP40ZL/NP41ZL (Motorized focus)

1. Press the FOCUS button.

The [LENS FOCUS] control screen will be displayed on.



Press ◀▶ buttons to adjust focus.

2. When the cursor is on the [CENTER] on on-screen menu, press either ◀ or ▶ button to align focus around the optical axis.

* The picture shows an example when the lens shift is moved upward. The focus for the lower part of the screen is aligned.

When the lens is at the center, the focus for the center of the screen is aligned.

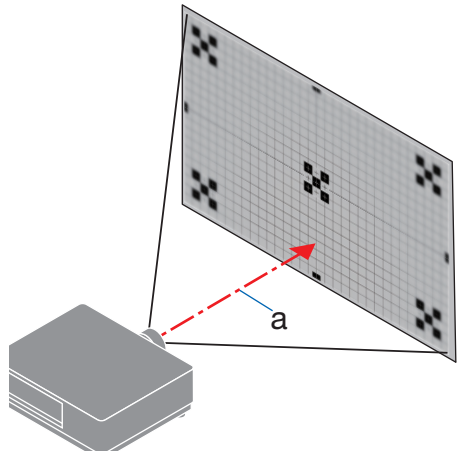
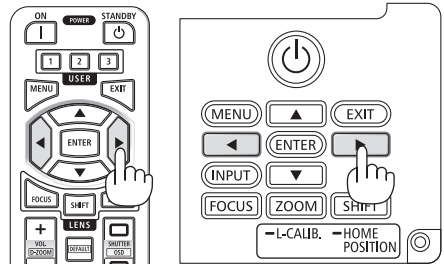
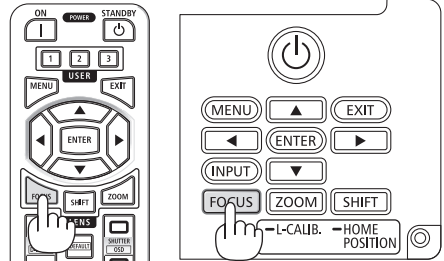

a: Optical axis

2. Projecting an Image (Basic Operation)

3. Press ▼ button to select the [PERIPHERY] on the on-screen menu, and then press either ◀ or ▶ button to align the focus of screen peripheral area. During this operation, the focus for around the optical axis will be maintained.

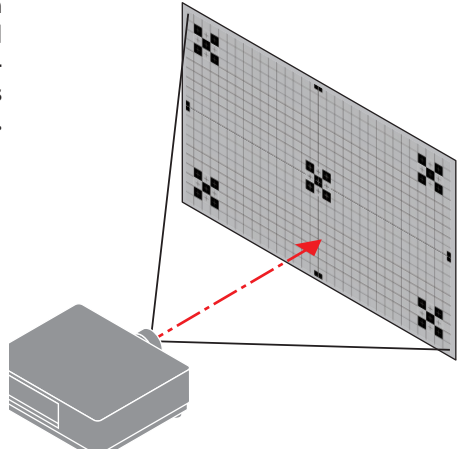

Applicable lens: NP43ZL/NP50ZL (Motorized focus)

1. Press the FOCUS button.

The [LENS FOCUS] control screen will be displayed on.



Press ◀▶ buttons to adjust focus.

* [PERIPHERY] LENS FOCUS is not available for this lens unit.

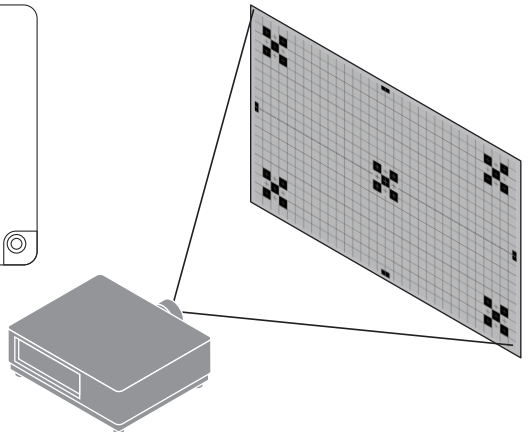
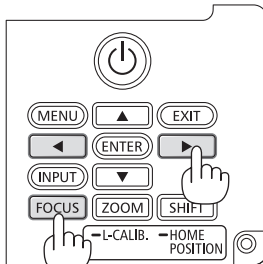
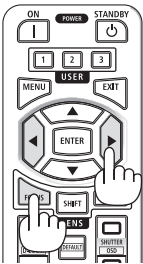

Applicable lens: NP44ML (Motorized focus)

- The NP44ML must be fixed to the projector using the separately sold support kit (NP01LK). The support kit is not shown on this illustration.

1. Press the FOCUS button.

The [LENS FOCUS] control screen will be displayed on.



Press ◀▶ buttons to adjust focus of screen center.

- * Does not work for [PERIPHERY] on the [LENS FOCUS] screen. Use the [LENS ZOOM] control screen to adjust the focus of the peripheral area.

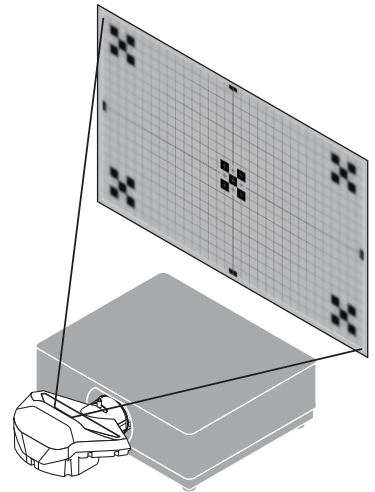
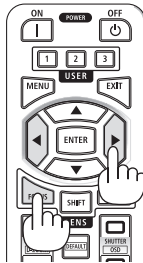

2. Press the ZOOM/L-CALIB. button on the cabinet.

The [LENS ZOOM] control screen will be displayed on.

- * In another way, press the ZOOM button on the remote control.



Press ◀▶ buttons to align the focus of screen peripheral area.

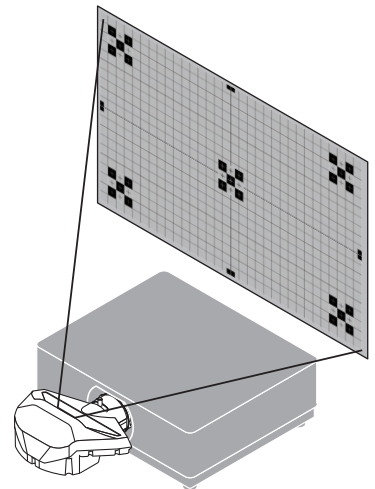
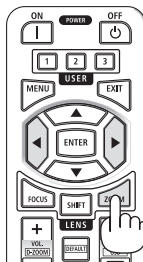

Zoom

Applicable lens: NP12ZL/NP13ZL/NP14ZL/NP15ZL (Manual zoom)

Turn the zoom ring clockwise and counterclockwise.

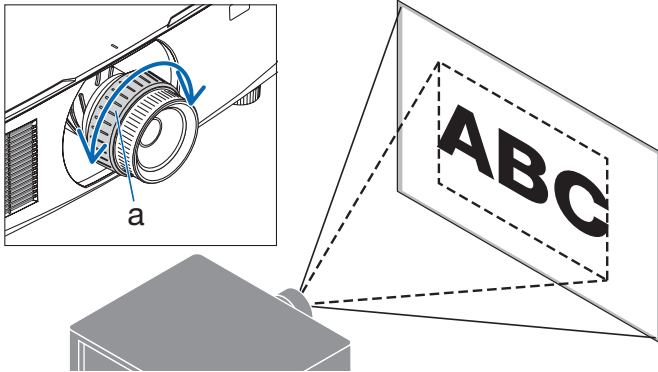

a: Zoom ring

Applicable lens: NP40ZL/NP41ZL/NP43ZL/NP50ZL (Motorized zoom)

1. Press ZOOM/L-CALIB. button.

The [ZOOM] adjustment screen will be displayed on.



- * In another way, press the ZOOM button on the remote control.
Press ◀▶ buttons to adjust zoom.

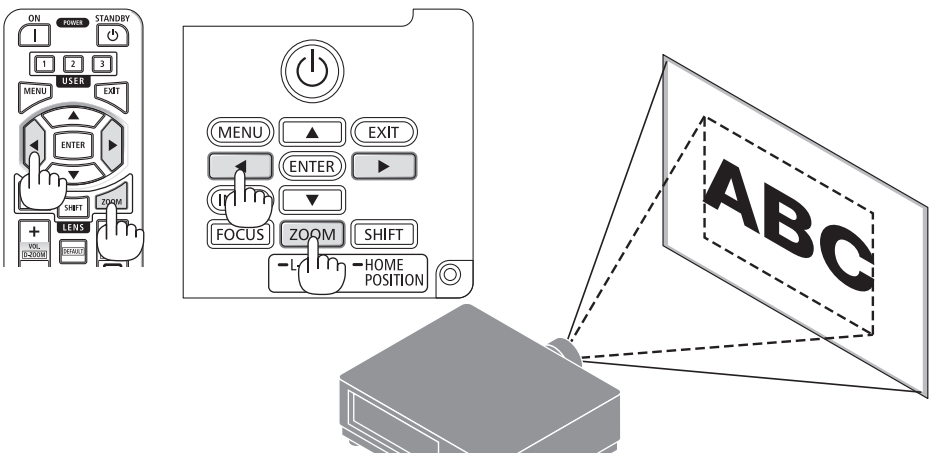

Adjusting the Tilt Foot

1. Turn the left and right tilt foot to adjust.

The tilt foot lengthen and shorten when turned. Turn one of the tilt foot to adjust the image so that it is level.

- The tilt foot can be lengthened by a maximum of 20 mm/0.8".
- The tilt foot can be used to tilt the projector by a maximum of 4°.

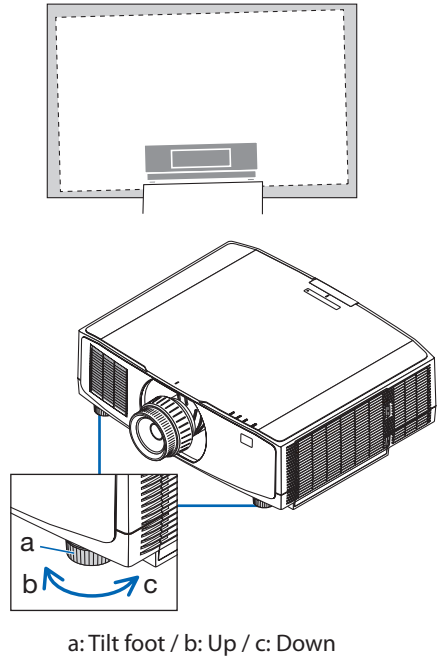

NOTE:

- Do not lengthen the tilt foot any more than 20 mm/0.8". Doing so will make the projector unstable.
- Do not use the tilt foot for any purpose other than adjusting inclination of the projector installation angle. Handling the tilt foot improperly, such as carrying the projector by grasping the tilt foot or hooking it onto a wall using the tilt foot, could damage the projector.

2-6. Adjusting a picture and sound

Adjusting the picture

Display the on-screen menu and adjust the picture. (→ page 61)

Turning Up or Down Volume

Sound level from the AUDIO OUT terminal can be adjusted.

Important:

- Do not turn up the volume to the maximum level on the external speaker system connected to the AUDIO OUT of the projector. Doing so may produce an unexpected, loud sound at the time of turning on or off the projector, causing damage to your hearing. When adjusting the volume on the external speaker system, set volume level of the speaker system to less than half its rating and adjust the volume on the projector to get appropriate sound level.



When no menus appear, the ◀ and ▶ buttons on the projector cabinet work as a volume control.

- On the remote control, press the VOL./D-ZOOM (+) or (-) button.
 - +: Increase volume
 - : Decrease volume

NOTE:

- The volume cannot be adjusted using the ◀ or ▶ button in the following cases.
 - When the on-screen menu is displayed
 - When the screen is enlarged by pressing the VOL./D-ZOOM (+) (-) buttons while holding down the CTL button on the remote control

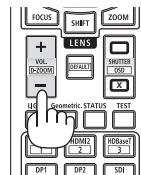
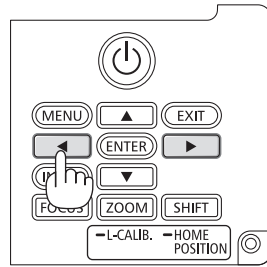



2-7. Turning off the Projector

To turn off the projector:

1. First, press the  (POWER) button on the projector cabinet or the POWER STANDBY button on the remote control.

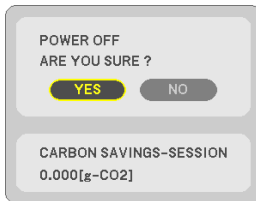
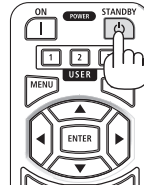
The [POWER OFF / ARE YOU SURE ? / CARBON SAVINGS-SESSION 0.000[g-CO2]] message will appear.



2. Secondly, press the ENTER button or press the  (POWER) or the POWER STANDBY button again.

The light source will be turned off and the power supply will be cut.

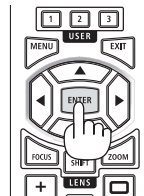

CAUTION

- Parts of the projector may become temporarily heated if the projector is turned off with the POWER button or if the AC power supply is disconnected during normal projector operation. Use caution when picking up the projector.

NOTE:

- While the POWER indicator is blinking blue in short cycles, the power cannot be turned off.
- If the operation to turn off the power is performed while the lens is moving, the power will not turn off until movement of the lens is completed.
- Do not unplug the power cord from the projector or from the power outlet while an image is being projected. Doing so could deteriorate the projector's AC IN terminal or the power plug's contact. To turn off the AC power while an image is being projected, use the breaker, etc.
- Do not disconnect the AC power supply to the projector within 10 seconds of making adjustment or setting changes and closing the menu. Doing so can cause loss of adjustments and settings.

2-8. After Use

1. Unplug the power cord.

For pulling out the power plug, press and hold the protruded section on the left and right sides of the power cord stopper.

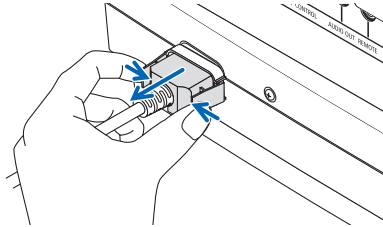

2. Disconnect any other cables.

3. Mount the lens cap on the lens.

4. Before moving the projector, screw in the tilt foot if they have been lengthened.

3. Convenient Features

3-1. Turn off the light of the projector (SHUTTER)

1. Press the SHUTTER CLOSE (X) button on the remote control.

The light source will turn off temporarily.

Press the SHUTTER OPEN (□) button to allow the screen to become illuminated again.

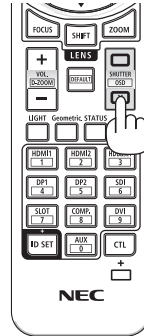

3-2. Turning Off the On-Screen Menu (On-Screen Mute)

1. Hold down the CTL button on the remote control and press the OSD CLOSE (X) button.

The on-screen menu, input terminal, etc. will disappear.

- To display the on-screen display, press the OSD OPEN (□) button while holding down the CTL button on the remote control.

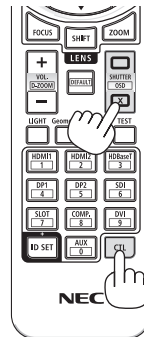

TIP:

- To confirm that the on-screen mute is turned on, press the MENU button. If the on-screen menu is not displayed even though you press the MENU button, it means the on-screen mute is turned on.
 - The on-screen mute is maintained even when the projector is turned off,
 - Holding down the MENU button on the projector cabinet for at least 10 seconds will turn off the on-screen mute.
-

3-3. Enlarging a Picture

You can enlarge the picture up to four times.

1. Press and hold the CTL button and then press VOL./D-ZOOM (+) button on the remote control to magnify the picture.

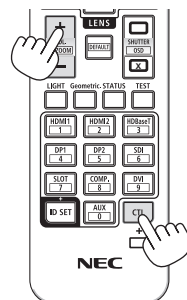
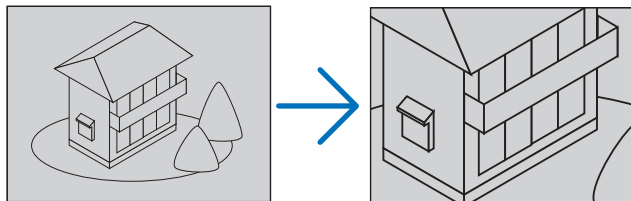

2. Press the ▲▼◀▶ button.

The area of the magnified image will be moved

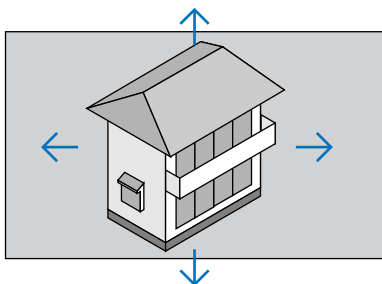

3. Press and hold the CTL button and then press VOL./D-ZOOM (-) button on the remote control.

Each time the button is pressed, the image is reduced.

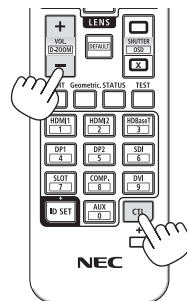

NOTE:

- The image will be enlarged or reduced at the center of the screen.
- Displaying the menu will cancel the current magnification.

3-4. Adjustment of luminance (brightness)

Three [LIGHT MODE] options can be selected according to the purpose of use. You can also adjust output power and change luminance (brightness).

LIGHT MODE	Icon at the bottom of the menu	Description
NORMAL		Standard mode. You can adjust the output from 70 to 100% using [LIGHT ADJUST].
SILENT		This mode prioritizes reducing operating noise. You can adjust the output from 70 to 90% using [LIGHT ADJUST].
LONG LIFE		This mode prioritizes prolonging the life of the optical components. You can adjust the output from 70 to 90% using [LIGHT ADJUST].

Display the [LIGHT MODE] screen

1. Press LIGHT button on the remote control.

The [LIGHT MODE] screen will be displayed.

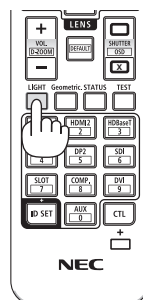

Change [LIGHT MODE]

1. With the cursor adjusted to [LIGHT MODE], press the ENTER button.

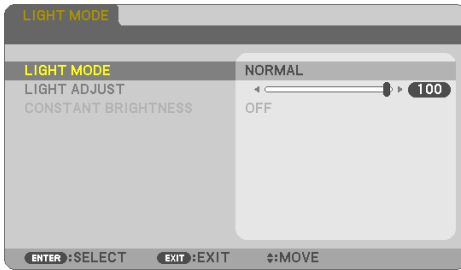

The [LIGHT MODE] selection screen will be displayed.

2. Use the ▼▲ buttons to make a selection, and press the ENTER button.

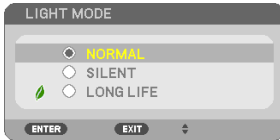

The display will return to the [LIGHT MODE] screen and the selected option will be applied. Press the MENU button to return to the original screen.

Perform [LIGHT ADJUST]

1. Press the ▼ button to adjust the cursor to [LIGHT ADJUST].



2. Press the ◀▶ button to adjust.

Press the MENU button to cancel the menu screen.

NOTE:

- Setting [CONSTANT BRIGHTNESS] to [ON] will maintain the degree of luminance (brightness) after the light is adjusted. (→ page 72)
 - The light module hours used can be checked in [USAGE TIME] on the menu. Select [INFO.] → [USAGE TIME].
 - After a lapse of 1 minute from when the projector displays a blue, black or logo screen, the projector goes into power saving mode and the brightness of the projected image will decrease. When the projector detects the input signal, it will return to original brightness.
 - The projector's protection functions may temporarily reduce luminance (brightness) in hot operating environments. The TEMP. indicator will light up in orange when the protection functions are active. At the same time, the Thermometer symbol [] is displayed at the lower right of the menu screen. The temperature inside the projector decreases due to the room temperature being lowered, returning to the original brightness.
-

Checking Energy-Saving Effect [CARBON METER]

This will display the energy-saving effect during the period of reduced projector light source as the amount of CO₂ h emission reductions. This feature is called as [CARBON METER].

There are two messages: [TOTAL CARBON SAVINGS] and [CARBON SAVINGS-SESSION]. The [TOTAL CARBON SAVINGS] message shows the total amount of CO₂ emission reduction from the time of shipment up to now. You can check the information on [USAGE TIME] from [INFO.] of the menu. (→ page 88)

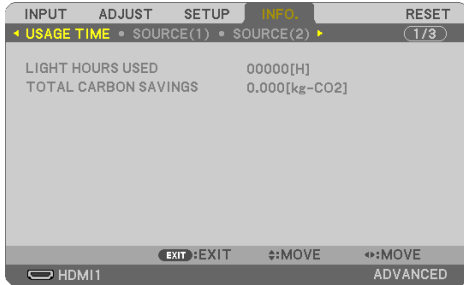

The [CARBON SAVINGS-SESSION] message shows the amount of CO₂ emission reduction between the time of power-on and the time of power-off. The [CARBON SAVINGS-SESSION] message will be displayed in the [POWER OFF / ARE YOU SURE ?] message at the time of power-off.

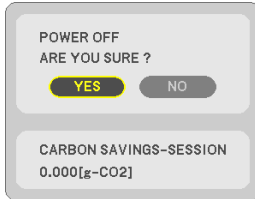

TIP:

- The formula shown below is used to calculate the amount of CO₂ emission reduction. Amount of CO₂ emission reduction = (Power consumption when using the unit with [LIGHT MODE] set to [NORMAL] and [LIGHT ADJUST] set to 100 – Power consumption in current setting) × CO₂ conversion factor.*
 - * Calculation for amount of CO₂ emission reduction is based on an OECD publication “CO₂ Emissions from Fuel Combustion”.
 - The [TOTAL CARBON SAVINGS] is calculated based on savings recorded in 15 minutes intervals.
 - The power consumption when the projector is in standby mode is excluded from the calculation of the amount of CO₂ emission reduction.
-

3-5. Correcting Keystone Distortion [KEYSTONE]

When the projector is not exactly perpendicular to the screen, keystone distortion occurs. For correcting this distortion, you can use the “Keystone” function, a digital technology that can adjust for keystone-type distortion, resulting in a crisp, square image.

Before performing KEYSTONE correction

The [KEYSTONE] correction has four features, [KEYSTONE HORIZONTAL], [KEYSTONE VERTICAL], [PINCUSHION LEFT/RIGHT], [PINCUSHION TOP/BOTTOM], and [CORNERSTONE]. When adjusting any of the corrected items, the other corrected items will be displayed in gray and cannot be selected. RESET the values to adjust other corrected items.

NOTE:

- Even when the projector is turned on, the last used correction values are applied.
- The KEYSTONE feature can cause an image to be slightly blurred because the correction is made electronically.

1. Press the Geometric. button on the remote control.

The [GEOMETRIC CORRECTION] screen will be displayed on the screen.

2. Move the cursor onto [MODE] by ▼ button and press the ENTER.

The mode selection screen will be displayed on.

3. Select [KEYSTONE] and press the ENTER.

Go back to display the [GEOMETRIC CORRECTION] screen of the on-screen menu.

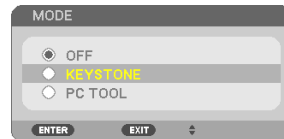
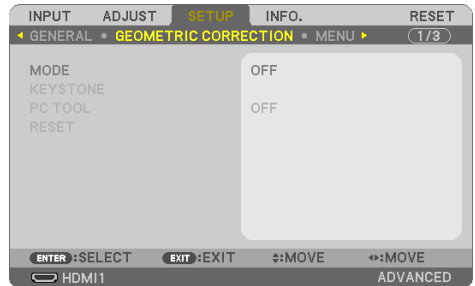

4. Press the ▼ button to align with the [KEYSTONE] and then press the ENTER button.

The screen will switch to the [KEYSTONE] screen.

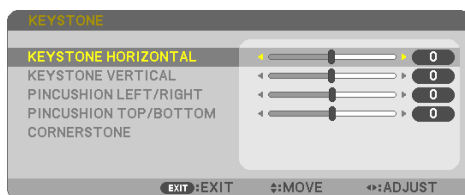
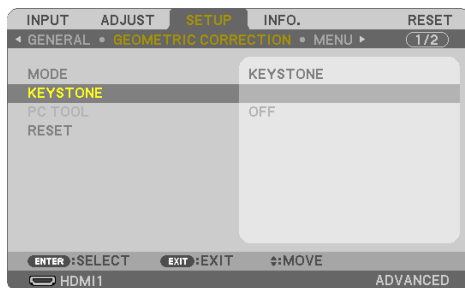

KEYSTONE VERTICAL/KEYSTONE HORIZONTAL

1. Press the ▼ button to select [KEYSTONE VERTICAL] and then use the ◀ or ▶ so that the left and right sides of the projected image are parallel.

- Adjust the vertical keystone distortion.

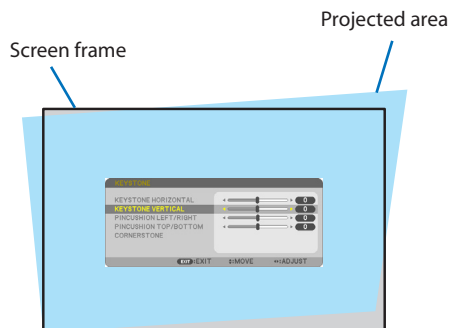

2. Align the left (or right) side of the screen with the left (or right) side of the projected image.

- Use the shorter side of the projected image as the base.
- In the right example, use the left side as the base.

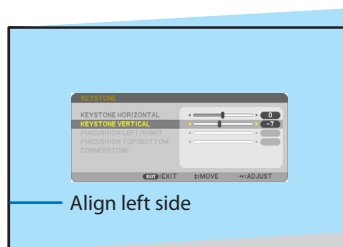

3. Press the ▲ button to select [KEYSTONE HORIZONTAL] and then use the ◀ or ▶ so that the top and bottom sides of the projected image are parallel.

- Adjust the horizontal keystone distortion.



4. Repeat steps 1 to 3 to correct keystone distortion.

5. After completing Keystone correction, press the EXIT button a few times to turn off the menu.



CORNERSTONE

1. Press the ▼ button to select [CORNERSTONE] and press the ENTER button.

The [CORNERSTONE] screen will be displayed.

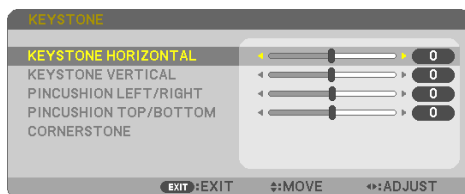

2. Project an image so that the screen is smaller than the area of the raster.

3. Pick up any one of the corners and align the corner of the image with a corner of the screen.

- * The drawing shows the upper right corner.

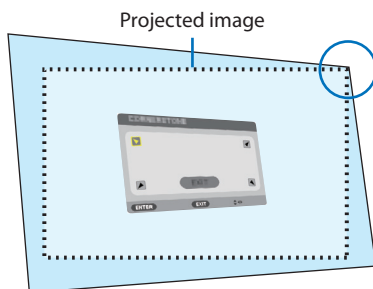

4. Use the ▲▼◀▶ button to select one icon (▲) which points in the direction you wish to move the projected image frame.
5. Press the ENTER button.

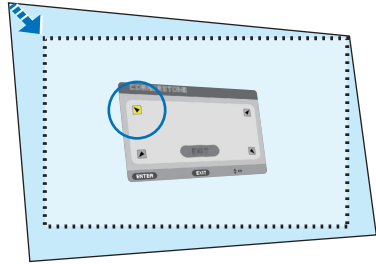

6. Use the ▲▼◀▶ button to move the projected image frame as shown on the example.
7. Press the ENTER button.

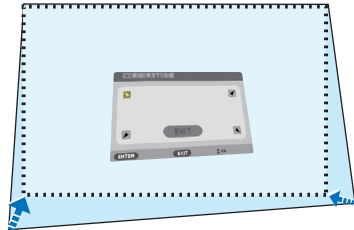

8. Use the ▲▼◀▶ button to select another icon which points in the direction.

On the Cornerstone adjustment screen, select [EXIT] or press the EXIT button on the remote control.

The confirmation screen is displayed.



9. Press the ◀ or ▶ button to highlight the [OK] and press the ENTER button.

This completes the Cornerstone correction.

- Selecting [CANCEL] will return to the adjustment screen without saving changes.
- Selecting [RESET] will return to the factory default.
- Selecting [UNDO] will exit without saving changes.

10. Press the EXIT button a few times to turn off the menu.



Pincushion

By this feature, it enables to adjust left and right side or top and bottom side independently for reforming pincushion distortion.

1. Press the ▼ or ▲ button to select [PINCUSHION LEFT/RIGHT] or [PINCUSHION TOP/BOTTOM].

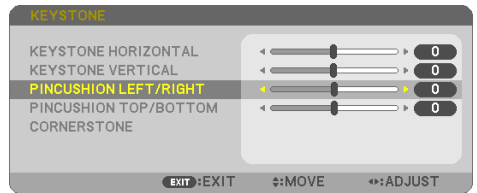

2. Press the ◀ or ▶ button to correct distortion.

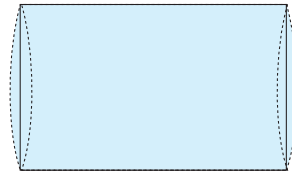

3. After completing [PINCUSHION] adjustment, press the EXIT button a few times to turn off the menu.

Reset the keystone adjustment to the default value

1. Display the [GEOMETRIC CORRECTION] screen, and make sure [KEYSTONE] is selected at [MODE].
2. Press the ▼ button to select [RESET] and press the ENTER button.



- Confirmation message is displayed on.
3. Move the cursor onto [YES] using either ◀ or ▶ button and then press the ENTER.



NOTE:

- All adjusted values set in the [KEYSTONE] adjustment are reset to initial values.

TIP:

- Distortion when projecting on specially shaped surfaces (cylindrical or spherical surfaces, for example) can be corrected using our ProAssist application. Please download ProAssist from our web site.
<https://www.sharp-nec-displays.com/dl/en/index.html>
-

3-6. Preventing the Unauthorized Use of the Projector [SECURITY]

A keyword can be set for your projector using the Menu to avoid operation by an unauthorized user. When a keyword is set, turning on the projector will display the Keyword input screen. Unless the correct keyword is entered, the projector cannot project an image.

- The [SECURITY] setting cannot be cancelled by using the [RESET] of the menu.

To enable the Security function:

1. **Press the MENU button.**
The menu will be displayed.
2. **Press the ► button twice to select [SETUP] and press the ▼ button or the ENTER button to select [GENERAL].**
3. **Press the ► button to select [INSTALLATION(1)].**
4. **Press the ▼ button three times to select [SECURITY] and press the ENTER button.**

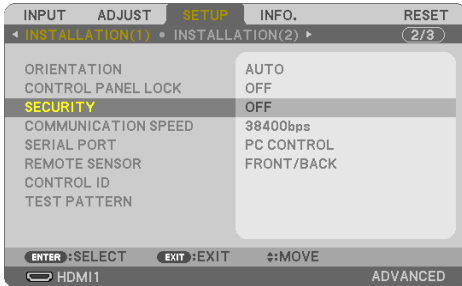

The [OFF]/[ON] menu will be displayed.

5. **Press the ▼ button to select [ON] and press the ENTER button.**



The [SECURITY KEYWORD] screen will be displayed.

6. **Type in a combination of the four ▲▼◀▶ buttons and press the ENTER button.**

NOTE:

- A keyword must be 4 to 10 digits in length.



The [CONFIRM KEYWORD] screen will be displayed.

NOTE:

- Make a note of your password and store it in a safe place.

7. Type in the same combination of ▲▼◀▶ buttons and press the ENTER button.

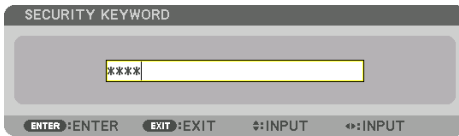

The confirmation screen will be displayed.

8. Select [YES] and press the ENTER button.



The [SECURITY] function has been enabled.

To turn on the projector when [SECURITY] is enabled:

1. Press the POWER ON button.

The projector will be turned on and display a message to the effect that the projector is locked.

2. Press the MENU button.

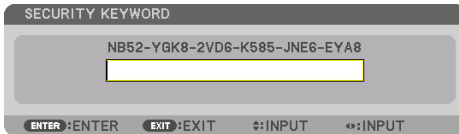

3. Type in the correct keyword and press the ENTER button. The projector will display an image.

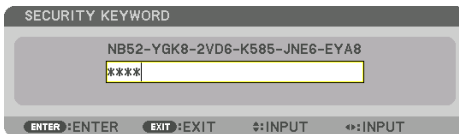

NOTE:

- The security disable mode is maintained until the main power is turned off or unplugging the power cord.

To disable the [SECURITY] function:

1. Press the MENU button.

The menu will be displayed.

2. Select [SETUP] → [INSTALLATION(1)] → [SECURITY] and press the ENTER button.

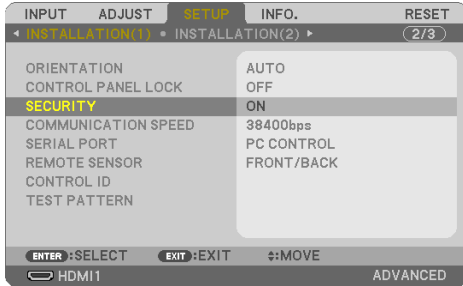

The [OFF]/[ON] menu will be displayed.

3. Select [OFF] and press the ENTER button.



The [SECURITY KEYWORD] screen will be displayed.

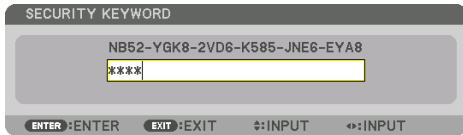

4. Type in your keyword and press the ENTER button.

When the correct keyword is entered, the [SECURITY] function will be disabled.

NOTE:

- If you forget your keyword, contact your dealer. Your dealer will provide you with your keyword in exchange for your request code. Your request code is displayed in the Keyword Confirmation screen. In this example [NB52-YGK8-2VD6-K585-JNE6-EYA8] is a request code.

3-7. Controlling the Projector by Using an HTTP Server

Overview

The HTTP Server function provides settings and operations for:

- Setting for network (wired LAN)
To use wired LAN connection, connect the projector to the computer with a commercially available LAN cable. (→ page 102)
- Setting Alert Mail (ALERT MAIL)
When the projector is connected to a network (wired LAN), the light source usage time or error messages will be sent via e-mail.
- Operating the projector
Power on/off, selecting input, volume control and picture adjustments are possible.
- Configure the [AMX BEACON], [Extron XTP], [HTTP SERVER], [PJLink], [CRESTRON] and other settings.

Important:

- The default [WIRED LAN] setting of this projector is set to [DISABLE (PROFILE)] when it is shipped from the factory. To connect to a network, display the on-screen menu and change the [WIRED LAN] profile setting in the [NETWORK SETTINGS] from [DISABLE] to [ENABLE] to enable the wired LAN.
- When setting up a [WIRED LAN] for the first time after purchasing the unit, be sure to set the [NETWORK PASSWORD]. (→ page 86)

How to access to the HTTP server:

- **Start the Web browser on the computer via the network connected to the projector and enter the following URL :**
http://<the projector's IP address>/index.html

TIP:

- The factory setting IP address is [DHCP: ON].
-

NOTE:

- To use the projector in a network, consult with your network administrator about network settings.
 - The display's or button's response can be slowed down or operation may not be accepted depending the settings of your network. Should this happen, consult your network administrator. The projector may not respond if its buttons are repeatedly pressed in rapid intervals. Should this happen, wait a moment and repeat. If you still can't get any response, turn off and back on the projector.
 - If the [NETWORK SETTINGS] screen does not appear in the web browser, press the Ctrl+F5 keys to refresh your web browser (or clear the cache).
 - This device uses "JavaScript" and "Cookies" and the browser should be set to accept these functions. The setting method will vary depending on the version of browser. Please refer to the help files and the other information provided in your software.
-

Preparation before Use

Connect the projector to a commercially available LAN cable before engaging in browser operations. (→ page 102)

Operation with a browser that uses a proxy server may not be possible depending on the type of proxy server and the setting method. Although the type of proxy server will be a factor, it is possible that items that have actually been set will not be displayed depending on the effectiveness of the cache, and the contents set from the browser may not be reflected in operation. It is recommended that a proxy server not be used unless it is unavoidable.

Handling of the Address for Operation via a Browser

Regarding the actual address that is entered for the address or entered to the URL column when operation of the projector is via a browser, the host name can be used as it is when the host name corresponding to the IP address of the projector has been registered to the domain name server by a network administrator, or the host name corresponding to the IP address of the projector has been set in the "HOSTS" file of the computer being used.

Example 1: When the host name of the projector has been set to "pj.nec.co.jp", access is gained to the network setting by specifying
 http://pj.nec.co.jp/index.html

for the address or the entry column of the URL.

Example 2: When the IP address of the projector is "192.168.73.1", access is gained to the network setting by specifying

http://192.168.73.1/index.html

for the address or the entry column of the URL.

PROJECTOR ADJUSTMENT

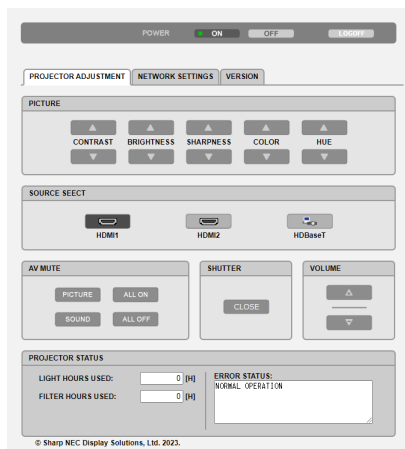

POWER	This controls the power of the projector.	
	ON	Power is switched on.
	OFF	Power is switched off.

PICTURE	Controls the video adjustment of the projector.	
	CONTRAST ▲	Increases the contrast adjustment value.
	CONTRAST ▼	Decreases the contrast adjustment value.
	BRIGHTNESS ▲	Increases the brightness adjustment value.
	BRIGHTNESS ▼	Decreases the brightness adjustment value.
	SHARPNESS ▲	Increases the sharpness adjustment value.
	SHARPNESS ▼	Decreases the sharpness adjustment value.
	COLOR ▲	Increases the color adjustment value.
	COLOR ▼	Decreases the color adjustment value.
	HUE ▲	Increases the hue adjustment value.
HUE ▼	Decreases the hue adjustment value.	
<ul style="list-style-type: none"> The functions that can be controlled will vary depending on the signal being input to the projector. (→ page 69) 		
SOURCE SELECT	This switches the input terminal of the projector.	
	HDMI1	Switches to the HDMI 1 IN terminal
	HDMI2	Switches to the HDMI 2 IN terminal.
	HDBaseT	Switch to image input sent from a transmission device that supports HDBaseT.
AV-MUTE	This controls the mute function of the projector.	
	PICTURE ON	Mutes the video.
	PICTURE OFF	Cancels the video muting.
	SOUND ON	Mutes the audio.
	SOUND OFF	Cancels the audio muting.
	ALL ON	Mutes each of the video, and audio functions.
ALL OFF	Cancels the muting of each of the video, and audio functions.	
SHUTTER	This controls the light source of the projector.	
	CLOSE	Turns off the light source and temporarily stop projection.
	OPEN	Turns on the light source.
VOLUME	This controls the volume of the projector.	
	▲	Increases the volume adjustment value.
	▼	Decreases the volume adjustment value.
PROJECTOR STATUS	This displays the condition of the projector.	
	LIGHT HOURS USED	Displays how many hours the light module has been used.
	FILTER HOURS USED	Displays how many hours the filter has been used.
	ERROR STATUS	Displays the status of errors occurring within the projector.
LOG OFF	Logging off your projector and returning to the authentication screen (LOGON screen).	

NETWORK SETTINGS

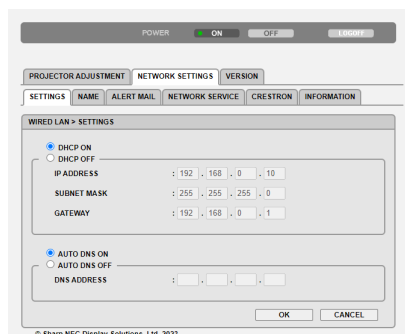

SETTINGS

Select whether the wired LAN will be active or inactive.

Configure wired LAN settings in the [SETTINGS] menu. See the explanations in the on-screen menu for details on each setting. (→ page 87)

NAME

PROJECTOR NAME	Set a unique projector name.	Up to 16 alphanumeric characters
HOST NAME	Set a host name of the projector.	Up to 16 alphanumeric characters

ALERT MAIL

ALERT MAIL	This option will notify your computer of error messages via e-mail when using wireless or wired LAN. <ul style="list-style-type: none"> Placing a checkmark will turn on the Alert Mail feature. Clearing a checkmark will turn off the Alert Mail feature. 	—
SENDER'S ADDRESS	Specify the sender's address.	Up to 60 alphanumeric characters
SMTP SERVER NAME	Type in the SMTP server name to be connected to the projector.	Up to 60 alphanumeric characters
RECIPIENT'S ADDRESS 1 RECIPIENT'S ADDRESS 2 RECIPIENT'S ADDRESS 3	Type in your recipient's address. Up to three addresses can be entered.	Up to 60 alphanumeric characters

TEST MAIL	<p>Send a test mail to check if your settings are correct.</p> <hr/> <p>NOTE:</p> <ul style="list-style-type: none"> • If you entered an incorrect address in a test, you may not receive an Alert mail. Should this happen, check if the Recipient's Address is correctly set. • Unless any one of the [SENDER'S ADDRESS], [SMTP SERVER'S NAME] or [RECIPIENT'S ADDRESS 1-3] is selected, [TEST MAIL] is not available. 	—
SAVE	Click this button to save the above settings on the projector.	—

NETWORK SERVICE

AMX BEACON	<p>Turn on or off for detection from AMX Device Discovery when connecting to the network supported by AMX's NetLinX control system.</p> <hr style="border-top: 1px dashed black;"/> <p>TIP:</p> <ul style="list-style-type: none"> • When using a device that supports AMX Device Discovery, all AMX NetLinX control system will recognize the device and download the appropriate Device Discovery Module from an AMX server. <hr style="border-top: 1px dashed black;"/> <ul style="list-style-type: none"> • Placing a checkmark will enable detecting the projector from AMX Device Discovery.. • Clearing a checkmark will disable detecting the projector from AMX Device Discovery. 	—
Extron XTP	<p>Set for connecting this projector to the Extron XTP transmitter.</p> <ul style="list-style-type: none"> • Placing a checkmark will enable to connect with the XTP transmitter. • Clearing a checkmark will disable to connect with the XTP transmitter. 	—
HTTP	Set a password for HTTP server.	Up to 10 alphanumeric characters
PJLink	<p>Configure the settings for using PJLink.</p> <p>PASSWORD: Set the password.</p> <p>CLASS: Switches between Class 1 and Class 2.</p> <p>NOTIFICATION: Enable or disable the notification function.</p> <p>NOTIFIED ADDRESS: Input the IP address of the notification.</p> <hr/> <p>NOTE:</p> <ul style="list-style-type: none"> • What is PJLink? PJLink is a standardization of protocol used for controlling projectors of different manufacturers. This standard protocol is established by Japan Business Machine and Information System Industries Association (JBMIA) in 2005. 	<p>PASSWORD: Up to 32 alphanumeric characters</p>

TIP:

- If you forget your password, consult with your dealer.

CRESTRON

Crestron RoomView	ROOMVIEW for managing from the computer. <ul style="list-style-type: none"> • DISABLE: Disables ROOMVIEW. • ENABLE: Enables ROOMVIEW. 	—
Crestron Control	CRESTRON CONTROL for managing from the controller. <ul style="list-style-type: none"> • DISABLE: Disables CRESTRON CONTROL. • ENABLE: Enables CRESTRON CONTROL. IP ADDRESS: Set your IP address of CRESTRON SERVER. IP ID: Set your IP ID of CRESTRON SERVER.	IP ID Up to 5 alphanumeric characters

TIP:

- The CRESTRON settings are required only for use with CRESTRON ROOMVIEW.

For more information, visit <https://www.crestron.com>

INFORMATION

WIRED LAN	Display a list of settings of wired LAN connection.
UPDATE	Reflect settings when they are changed.

VERSION

Displays the firmware and data version of the unit.

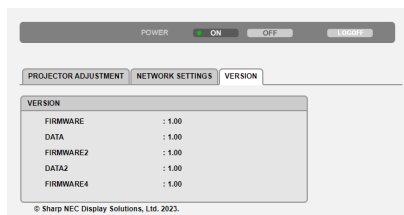

4. Using On-Screen Menu

4-1. Using the Menus

NOTE:

- The on-screen menu may not be displayed correctly while interlaced motion video image is projected.
-

1. Press the **MENU** button on the remote control or the projector cabinet to display the menu.



NOTE:

- The commands such as ENTER, EXIT, ▲▼, ◀▶ in the bottom show available buttons for your operation.
-

2. Press the ◀▶ buttons on the remote control or the projector cabinet to display the sub-menu.
3. Press the ENTER button on the remote control or the projector cabinet to highlight the top item or the first tab.
4. Use the ▲▼ buttons on the remote control or the projector cabinet to select the item you want to adjust or set.

You can use the ◀▶ buttons on the remote control or the projector cabinet to select the tab you want.

5. Press the ENTER button on the remote control or the projector cabinet to display the submenu window.
6. Adjust the level or turn the selected item on or off by using the ▲▼◀▶ buttons on the remote control or the projector cabinet.

Changes are stored until adjusted again.

7. Repeat steps 2–6 to adjust an additional item, or press the EXIT button on the remote control or the projector cabinet to quit the menu display.
-

NOTE:

- When a menu or message is displayed, several lines of information may be lost, depending on the signal or settings.
-

8. Press the **MENU** button to close the menu.
To return to the previous menu, press the **EXIT** button.

Menu Elements

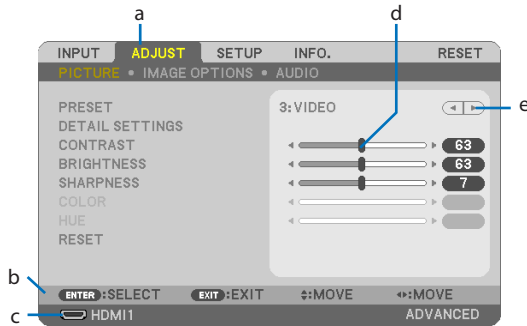

a: Tab / b: Available buttons / c: Source / d: Slide bar / e: Solid triangle

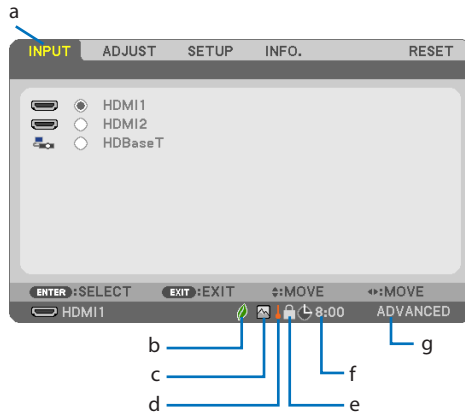

a: Highlight / b: LIGHT MODE symbol / c: High Altitude symbol / d: Thermometer symbol / e: Key Lock symbol / f: Off Timer remaining time / g: Menu mode

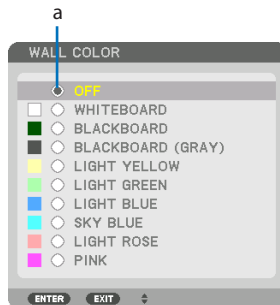

a: Radio button

Menu windows or dialog boxes typically have the following elements:

Highlight	Indicates the selected menu or item.
Solid triangle	Indicates further choices are available. A highlighted triangle indicates the item is active.
Tab	Indicates a group of features in a dialog box. Selecting on any tab brings its page to the front.
Radio button	Use this round button to select an option in a dialog box.
Source	Indicates the currently selected source.
Off Timer remaining time	Indicates the remaining countdown time when the [OFF TIMER] is preset.
Slide bar	Indicates settings or the direction of adjustment.
LIGHT MODE symbol	Indicates [LIGHT MODE] is set to [LONG LIFE].
Key Lock symbol	Indicates the [CONTROL PANEL LOCK] is enabled.
Thermometer symbol	Indicates that the heat protection functions are operating.
High Altitude symbol	Indicates the [FAN MODE] is set to [HIGH ALTITUDE] mode.
Menu mode	Indicate the [ADVANCED] menu or [BASIC] menu.

4-2. List of Menu Items

Some menu items are not available depending on the input source. The below listed menu items are on the advanced menu. The mark (B) is added to the items on the basic menu.

Shaded characters (■) represent default settings.

Menu Item		Options			
INPUT	HDMI1	(B)			
	HDMI2	(B)			
	HDBaseT	(B)			
ADJUST	PICTURE	PRESET	1-7		
		DETAIL SETTINGS	GENERAL	REFERENCE	HIGH-BRIGHT, PRESENTATION, VIDEO, MOVIE, GRAPHIC, sRGB, DICOM SIM.
				GAMMA CORRECTION	DYNAMIC, NATURAL, BLACK DETAIL
				SCREEN SIZE	LARGE, MEDIUM, SMALL
				COLOR TEMPERATURE	
				DYNAMIC CONTRAST	OFF, ON
				COLOR ENHANCEMENT	OFF, LOW, MEDIUM, HIGH
		WHITE BALANCE	CONTRAST R		
			CONTRAST G		
			CONTRAST B		
			BRIGHTNESS R		
			BRIGHTNESS G		
		CONTRAST	(B)		
		BRIGHTNESS	(B)		
	SHARPNESS	(B)			
	COLOR	(B)			
	HUE	(B)			
	RESET	(B)			
	IMAGE OPTIONS	OVERSCAN	AUTO, 0[%], 5[%], 10[%]		
		ASPECT RATIO	AUTO, 4:3, 16:9, 15:9, 16:10, LETTERBOX, NATIVE		
	AUDIO	VOLUME	(B)		

4. Using On-Screen Menu

Menu Item		Options		
SETUP	GENERAL	WALL COLOR (B)	OFF, WHITEBOARD, BLACKBOARD, BLACKBOARD (GRAY), LIGHT YELLOW, LIGHT GREEN, LIGHT BLUE, SKY BLUE, LIGHT ROSE, PINK	
		LIGHT MODE (B)	LIGHT MODE	NORMAL, SILENT, LONG LIFE
			LIGHT ADJUST	
			CONSTANT BRIGHTNESS	OFF, ON
		OFF TIMER (B)	OFF, 0:30, 1:00, 2:00, 4:00, 8:00, 12:00, 16:00	
		ADMINISTRATOR MODE (B)	MENU MODE	ADVANCED, BASIC
			NOT SAVE SETTING VALUES	OFF, ON
			KEYWORD	OFF, ON
		LANGUAGE (B)	ENGLISH, DEUTSCH, FRANÇAIS, ITALIANO, ESPAÑOL, SVENSKA, 日本語	
			DANSK, PORTUGUÊS, ČEŠTINA, MAGYAR, POLSKI, NEDERLANDS, SUOMI	
	NORSK, TÜRKÇE, РУССКИЙ, عربي, ΕΛΛΗΝΙΚΑ, 简体中文, 한국어, TIÉNG VIÉT			
	ROMÂNĂ, HRVATSKI, БЪЛГАРСКИ, INDONESIA, हिन्दी, ไทย, نۇيغۇر, 繁體中文			
	GEOMETRIC CORRECTION	MODE		OFF, KEYSTONE, PC TOOL
		KEYSTONE	KEYSTONE HORIZONTAL	
			KEYSTONE VERTICAL	
			PINCUSHION LEFT/RIGHT	
			PINCUSHION TOP/BOTTOM	
			CORNERSTONE	
		PC TOOL		OFF, 1, 2, 3
	RESET			
	MENU	COLOR SELECT		COLOR, MONOCHROME
		INPUT DISPLAY		OFF, ON
		ID DISPLAY		OFF, ON
		MESSAGE		OFF, ON
		DISPLAY TIME		MANUAL, AUTO 5 SEC, AUTO 15 SEC, <u>AUTO 45 SEC</u>
		BACKGROUND		BLUE, BLACK, LOGO
		FILTER MESSAGE		OFF, 500[H], 1000[H], 1500[H], 2000[H], 2500[H], 3000[H], 3500[H], 4000[H]
INSTALLATION(1)	ORIENTATION		AUTO, DESKTOP FRONT, CEILING REAR, DESKTOP REAR, CEILING FRONT	
	CONTROL PANEL LOCK		OFF, ON	
	SECURITY		OFF, ON	
	COMMUNICATION SPEED		4800bps, 9600bps, 19200bps, <u>38400bps</u>	
	SERIAL PORT		PC CONTROL, HDBaseT	
	REMOTE SENSOR		FRONT/BACK, FRONT, BACK, HDBaseT	
	CONTROL ID	CONTROL ID NUMBER	1-254	
		CONTROL ID	OFF, ON	
	TEST PATTERN			
INSTALLATION(2)	REF. WHITE BALANCE	CONTRAST R		
		CONTRAST G		
		CONTRAST B		
		BRIGHTNESS R		
		BRIGHTNESS G		
	BRIGHTNESS B			
	LENS HOME			
LENS CALIBRATION				

4. Using On-Screen Menu

Menu Item		Options		
SETUP	OPTIONS(1)	SEAMLESS SWITCHING	OFF, ON	
		FAN MODE	AUTO, HIGH ALTITUDE	
		WXGA MODE	OFF, ON	
		VIDEO LEVEL	HDMI1	AUTO, NORMAL, ENHANCED
			HDMI2	AUTO, NORMAL, ENHANCED
			HDBaseT	AUTO, NORMAL, ENHANCED
		OPTIONS(2)	STANDBY MODE	NORMAL, NETWORK STANDBY, SLEEP
	DIRECT POWER ON		OFF, ON	
	AUTO POWER ON		OFF, AUTO, HDMI1, HDMI2	
	AUTO POWER OFF		TIME	1-60
			MODE	OFF, ON
	DEFAULT INPUT SELECT		LAST, AUTO, HDMI1, HDMI2, HDBaseT	
	STATIC CONVERGENCE		HORIZONTAL R	
			HORIZONTAL G	
			HORIZONTAL B	
			VERTICAL R	
			VERTICAL G	
	VERTICAL B			
	NETWORK SETTINGS	NETWORK PASSWORD		
		WIRED LAN	INTERFACE	LAN, HDBaseT
			PROFILE	DISABLE, ENABLE
			DHCP	OFF, ON
			IP ADDRESS	
			SUBNET MASK	
			GATEWAY	
			AUTO DNS	OFF, ON
DNS				
RECONNECT				
HTTP SERVER		OFF, ON		

4. Using On-Screen Menu

		Menu Item	Options
INFO.	USAGE TIME (B)	LIGHT HOURS USED	
		FILTER HOURS USED	
		TOTAL CARBON SAVINGS	
	SOURCE(1) (B)	SOURCE NAME	
		SOURCE INDEX	
		HORIZONTAL FREQUENCY	
		VERTICAL FREQUENCY	
		SYNC POLARITY	
		SCAN TYPE	
	SOURCE(2) (B)	SIGNAL TYPE	
		VIDEO TYPE	
		BIT DEPTH	
		VIDEO LEVEL	
	HDBaseT	SIGNAL QUALITY	
		OPERATION MODE	
		LINK STATUS	
		HDMI STATUS	
	WIRED LAN	IP ADDRESS	
		SUBNET MASK	
		GATEWAY	
		MAC ADDRESS	
	VERSION(1) (B)	FIRMWARE	
		DATA	
	VERSION(2) (B)	FIRMWARE2	
		DATA2	
		FIRMWARE4	
	OTHERS (B)	PROJECTOR NAME (B)	
		HOST NAME (B)	
		MODEL NO. (B)	
		SERIAL NUMBER (B)	
CONTROL ID (when [CONTROL ID] is set) (B)			
LENS ID			
CONDITIONS	INTAKE TEMPERATURE		
	EXHAUST TEMPERATURE		
	INSTALLATION POSITION		
	X-AXIS		
	Y-AXIS		
	Z-AXIS		
RESET	CURRENT SIGNAL		
	ALL DATA		
	CLEAR FILTER HOURS		

4-3. Menu Descriptions & Functions [INPUT]

[HDMI1] and [HDMI2]

Selects the HDMI compatible equipment connected to your HDMI 1 IN or HDMI 2 IN terminal.

[HDBaseT]

Projects the signal transmitted from the terminals supported HDBaseT.

4-4. Menu Descriptions & Functions [ADJUST]

[PICTURE]

[PRESET]

This function allows you to select optimized settings for your projected image.

You can adjust neutral tint for yellow, cyan or magenta.

There are seven factory presets optimized for various types of images. You can also use [DETAIL SETTINGS] to set user adjustable settings to customize each gamma or color.

Your settings can be stored in [PRESET] 1 to [PRESET] 7.

HIGH-BRIGHT	Recommended for use in a brightly lit room.
PRESENTATION	Recommended for making a presentation using a PowerPoint file.
VIDEO	Recommended for typical TV program viewing.
MOVIE	Recommended for movies.
GRAPHIC	Recommended for graphics.
sRGB	Standard color values
DICOM SIM.	Recommended for DICOM simulation format.

NOTE:

- The [DICOM SIM.] option is for training/reference only and should not be used for actual diagnosis.
- DICOM stands for Digital Imaging and Communications in Medicine. It is a standard developed by the American College of Radiology (ACR) and the National Electrical Manufacturers Association (NEMA).

The standard specifies how digital image data can be moved from system to system.

[DETAIL SETTINGS]

This function allows you to store your customized settings in [PRESET 1] to [PRESET 7]. First, select a base preset mode from [REFERENCE], then set [GAMMA CORRECTION], [SCREEN SIZE], [COLOR TEMPERATURE], [DYNAMIC CONTRAST], and [COLOR ENHANCEMENT].

Storing Your Customized Settings [REFERENCE]

Select a mode to serve as the basis for the [DETAIL SETTINGS].

Selecting Gamma Correction Mode [GAMMA CORRECTION]

Each mode is recommended for:

DYNAMIC	Creates a high-contrast picture.
NATURAL	Natural reproduction of the picture.
BLACK DETAIL	Emphasizes detail in dark areas of the picture.

NOTE:

- This function is not available when [DICOM SIM.] is selected for [REFERENCE].

Selecting Screen Size for DICOM SIM. [SCREEN SIZE]

This function will perform gamma correction appropriate for the screen size.

LARGE	For screen size of 300"
MEDIUM	For screen size of 200"
SMALL	For screen size of 100"

NOTE:

- This function is available only when [DICOM SIM.] is selected for [REFERENCE].

Adjusting Color Temperature [COLOR TEMPERATURE]

Adjust the balance of the colors (R, G, B) to optimize the color reproducibility.

A color temperature with a high numerical value becomes bluish white while one with a low numerical value becomes reddish white.

A value between 5000 K and 10500 K can be set in 100 K units.

NOTE:

- When [HIGH-BRIGHT] is selected in [REFERENCE], this function is not available.
-

Adjusting Brightness and Contrast [DYNAMIC CONTRAST]

If [ON] is selected, the most optimal contrast ratio is used according to the picture.

NOTE:

- When [CONSTANT BRIGHTNESS] is activated, [DYNAMIC CONTRAST] cannot be selected.
 - This function is not available when [DICOM SIM.] is selected for [REFERENCE].
-

Enhancing the Color [COLOR ENHANCEMENT]

This allows you to adjust the color density of the image.

The color of the image will become deeper in the order of [LOW], [MEDIUM], and [HIGH] as the displayed image will become darker.

With [OFF] selected, the [COLOR ENHANCEMENT] function will not work.

NOTE:

- This function is not available when [sRGB] or [DICOM SIM.] is selected for [REFERENCE].
-

Adjusting White Balance [WHITE BALANCE]

This allows you to adjust the white balance. Contrast for each color (RGB) to adjust the white level of the screen; Brightness for each color (RGB) is used to adjust the black level of the screen.

NOTE:

- When [WHITE BALANCE] is in operation, the actual color tone differs from the value of the [COLOR TEMPERATURE].
-

[CONTRAST]

Adjusts the intensity of the image according to the incoming signal.

[BRIGHTNESS]

Adjusts the brightness level or the back raster intensity.

[SHARPNESS]

Controls the detail of the image.

[COLOR]

Increases or decreases the color saturation level.

[HUE]

Varies the color level from +/- green to +/- blue. The red level is used as reference.

Input signal	CONTRAST	BRIGHTNESS	SHARPNESS	COLOR	HUE
HDMI/HDBaseT (RGB)	Yes	Yes	Yes	No	No
HDMI/HDBaseT (COMPONENT)	Yes	Yes	Yes	Yes	Yes

Yes = Adjustable, No = Not adjustable

[RESET]

The settings and adjustments for [PICTURE] will be returned to the factory settings with the exception of the following; Preset numbers and [REFERENCE] within the [PRESET] screen.

The settings and adjustments under [DETAIL SETTINGS] within the [PRESET] screen that are not currently selected will not be reset.

Selecting Overscan Percentage [OVERSCAN]

This allows you to set the appropriate overscan for an incoming signal.

When [AUTO] is selected, the over-scan that is most suitable for the input signal is carried out and displayed.

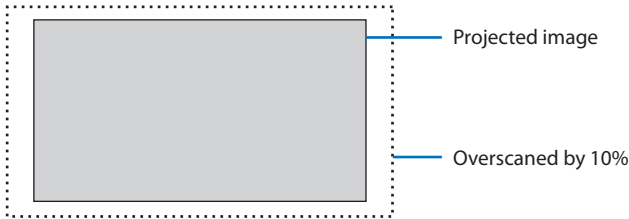

NOTE:

- The [OVERSCAN] item cannot be selected when VIDEO signals are used or when [NATIVE] is selected for [ASPECT RATIO].

Selecting Aspect Ratio [ASPECT RATIO]

The term “aspect ratio” refers to the ratio of width to height of a projected image.

The projector automatically determines the incoming signal and displays it in its appropriate aspect ratio.

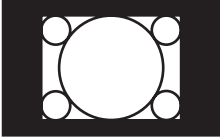
Options	Function
AUTO	The projector will automatically determine the incoming signal and display it in its aspect ratio. The projector may erroneously determine the aspect ratio depending on its signal. If this occurs, select the appropriate aspect ratio from the following.
4:3	The image is displayed in 4:3 aspect ratio.
16:9	The image is displayed in 16:9 aspect ratio.
15:9	The image is displayed in 15:9 aspect ratio.
16:10	The image is displayed in 16:10 aspect ratio.
LETTERBOX	The image of a letterbox signal is stretched equally in the horizontal and vertical directions to fit the screen. Parts of the displayed image are cropped at the top and bottom edges and therefore not visible.
NATIVE	<p>The projector displays the current image in its true resolution when the incoming computer signal has a lower resolution than the projector’s native resolution.</p> <p>[Example] When the incoming signal with the resolution of 800×600 is displayed:</p>  <p>The diagram shows a black square frame. Inside the frame, there is a large white circle centered in the square. At each of the four corners of the square, there is a smaller white circle. The circles are arranged such that they touch the corners of the square and each other, illustrating a signal with a lower resolution than the projector's native resolution.</p>
	<p>NOTE:</p> <ul style="list-style-type: none"> • When a non-computer signal is displayed, the [NATIVE] is not available. • When a signal with a higher resolution than the projector’s native resolution is displayed, [NATIVE] is not available.

[AUDIO]

Turning Up or Down Sound [VOLUME]

Adjusts the volume level of the audio output terminals.

4-5. Menu Descriptions & Functions [SETUP]

[GENERAL]

Using the Wall Color Correction [WALL COLOR]

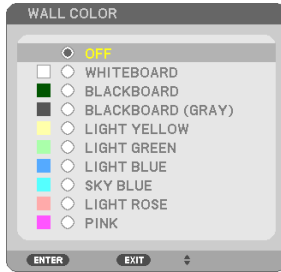

This function allows for quick adaptive color correction in applications where the screen material is not white.

NOTE:

- Selecting [WHITEBOARD] reduces brightness.

Adjusting brightness [LIGHT MODE]

Three [LIGHT MODE] options can be selected according to the purpose of use. You can also adjust output power and change luminance (brightness).

LIGHT MODE	NORMAL	This is the standard mode.
	SILENT	This mode prioritizes reducing operating noise.
	LONG LIFE	This mode prioritizes prolonging the life of the optical components.
LIGHT ADJUST	The output of each [LIGHT MODE] can be adjusted in 1%. The adjustment range will vary depending on the [LIGHT MODE] settings. NORMAL: 70 - 100% SILENT, LONG LIFE: 70 - 90%	
CONSTANT BRIGHTNESS	OFF	[CONSTANT BRIGHTNESS] mode will be canceled.
	ON	Maintains the brightness that is in effect at the time [ON] is selected. Unless [OFF] is selected, the same settings will remain in effect even when the projector is turned off. <ul style="list-style-type: none"> • To re-adjust the brightness, first turn this setting OFF before making further adjustments.
		NOTE: • [CONSTANT BRIGHTNESS] mode is a function used to maintain the brightness at a constant level. Color will not be fixed.

NOTE:

- You can select [CONSTANT BRIGHTNESS] in the following situations.
[LIGHT MODE] is [NORMAL] and [LIGHT ADJUST] is 70–95%.
[LIGHT MODE] is either [SILENT] or [LONG LIFE] and [LIGHT ADJUST] is 70–85%.
- When [CONSTANT BRIGHTNESS] is set to [ON], [LIGHT MODE] and [LIGHT ADJUST] cannot be selected.

TIP:

- Brightness normally decreases with use, but by selecting [CONSTANT BRIGHTNESS] mode, the projector automatically adjust the output based on the projector used time, thereby maintaining a constant brightness throughout the life of the light module.
However, if output is already at its maximum, brightness will decrease with use.

Using Off Timer [OFF TIMER]

- Select your desired time between 30 minutes and 16 hours: OFF, 0:30, 1:00, 2:00, 4:00, 8:00, 12:00, 16:00.
- Press the ENTER button on the remote control.
- The remaining time starts counting down.
- The projector will turn off after the countdown is complete.

NOTE:

- To cancel the preset time, set [OFF] for the preset time or turn off the power.
- When the remaining time reaches 3 minutes before the projector is turned off, the [THE PROJECTOR WILL TURN OFF WITHIN 3 MINUTES.] message will be displayed on the bottom of the screen.

Configuring the menu settings [ADMINISTRATOR MODE]

This allows you to select [MENU MODE], save settings, and set a [KEYWORD] for the [ADMINISTRATOR MODE].

MENU MODE	Select either [BASIC] or [ADVANCED] menu. (→ page 61)
NOT SAVE SETTING VALUES	When [ON] is selected, the values of the items configured in the on-screen menu will not be saved.
KEYWORD	Assign a password for the administrator mode. Enter the password using the ▲▼◀▶ buttons and press the ENTER button. (Up to 10 alphanumeric characters)

Selecting Menu Language [LANGUAGE]

You can choose one of 30 languages for on-screen instructions.

NOTE:

- Your setting will not be affected even when [RESET] is done from the menu.

[GEOMETRIC CORRECTION]**[MODE]**



Set pattern for correcting distortion. If [OFF] is selected, the [GEOMETRIC CORRECTION] becomes ineffective.

Correcting Keystone Distortion Manually [KEystone]

You can correct horizontal or vertical keystone, pincushion LEFT/RIGHT or TOP/BOTTOM, or corner-stone distortion manually.

NOTE:

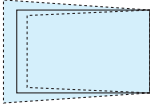
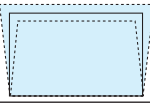
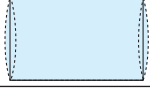
- [KEYSTONE HORIZONTAL] and [KEYSTONE VERTICAL] can be adjusted at once.
- To change from one item to another item, reset the first item.
- Adjustment values will be overwritten. They will not be deleted even when the projector is turned off.
- Using [KEYSTONE], [PINCUSHION] and [CORNERSTONE] correction can cause the image to be slightly blurred because the correction is made electronically.

KEYSTONE HORIZONTAL	Corrects horizontal keystone distortion. (→ page 44)	
KEYSTONE VERTICAL	Corrects vertical keystone distortion. (→ page 44)	
PINCUSHION LEFT/RIGHT	Corrects pincushion distortion at the left or right side. (→ page 47)	
PINCUSHION TOP/BOTTOM	Corrects pincushion distortion at the top or bottom side. (→ page 47)	
CORNERSTONE	Fits a projected image within the border of the screen easily by align the four corner of an image to the ones of the screen. (→ page 45)	

TIP:

- Adjustable range of the [KEYSTONE] and the [CORNERSTONE]:

Horizontal Direction	Vertical Direction
Approx. $\pm 30^\circ$ (Max)	Approx. $\pm 30^\circ$ (Max)

Adjustable range may be narrower depending on input signal.

[PC TOOL]

Recall the geometric correction data that is registered in the projector beforehand.
The geometric correction data using our ProAssist application (→ page 48) is registered here.

NOTE:

- As electrical correction is carried out in geometric correction, the brightness may be affected and the picture quality may be degraded.

[RESET]

Resets the item selected at [MODE] on the [GEOMETRIC CORRECTION] screen.
The operation differs depending on the mode selected at [MODE].

MODE	Operation
KEYSTONE	All the [KEYSTONE] adjustments are reset to their initial values.
PC TOOL	Turns off the [PC TOOL] setting. The registered data will not be reset.
OFF	Resetting is invalid.

TIP:

- Resetting can be executed by pressing and holding the Geometric. button on the remote control for over 2 seconds.

[MENU]**Selecting Menu Color [COLOR SELECT]**

You can choose between two options for menu color: [COLOR] and [MONOCHROME].

Turning On/Off Input Display [INPUT DISPLAY]

This option turns on or off input name display such as [HDMI1] to be displayed on the top right of the screen.

Turning On/Off Control ID [ID DISPLAY]

This option turns on or off the ID number which is displayed when the ID SET button on the remote control is pressed.

Turning On/Off Message [MESSAGE]

This option selects whether or not to display projector messages at the bottom of the projected image.

Even when [OFF] is selected, the security lock warning is displayed. The security lock warning turns off when the security lock is canceled.

Selecting Menu Display Time [DISPLAY TIME]

This option allows you to select how long the projector waits after the last touch of a button to turn off the menu. The preset choices are [MANUAL], [AUTO 5 SEC], [AUTO 15 SEC], and [AUTO 45 SEC]. The [AUTO 45 SEC] is the factory preset.

Selecting a Color or Logo for Background [BACKGROUND]

This option selects the desired background when there is no input signal.

BLUE	The background color is blue
BLACK	The background color is black
LOGO	Display an image as the background

NOTE:

- To change the background image to be displayed as a [LOGO], see Page 129.
- Your setting will not be affected even when [RESET] is done from the menu.
- The background cannot be changed when the on-screen mute function is activated.

Selecting Interval Time for Filter Message [FILTER MESSAGE]

This option allows you to select the time preference between displaying the message for cleaning the filters. Clean the filter when you get the message "PLEASE CLEAN FILTER."

Five options are available: OFF, 500[H], 1000[H], 1500[H], 2000[H], 2500[H], 3000[H], 3500[H], 4000[H]. The default setting is [OFF].

NOTE:



- Your setting will not be affected even when [RESET] is done from the menu.

[INSTALLATION(1)]**Selecting Projector Orientation [ORIENTATION]**

This reorients your image for your type of projection. The options are: desktop front projection, ceiling rear projection, desktop rear projection, and ceiling front projection.

⚠ WARNING

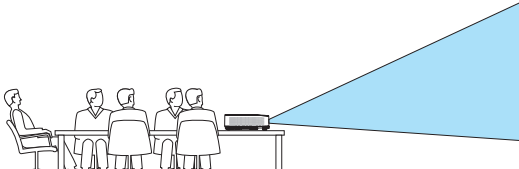
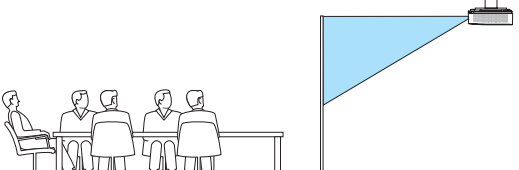
- Should special works be required, for example to suspend the projector from the ceiling, consult your dealer.
Never try to install the projector yourself in such cases. The projector could drop and cause injury.

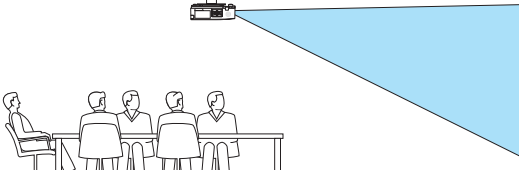
AUTO	When the light module is turned ON, the inner sensor of the projector detects its installation state either [DESKTOP FRONT] or [CEILING FRONT] and then switch its projection method
DESKTOP FRONT	
CEILING REAR	
DESKTOP REAR	
CEILING FRONT	

Disabling the Cabinet Buttons [CONTROL PANEL LOCK]

This option turns on or off the [CONTROL PANEL LOCK] function.

NOTE:

- This [CONTROL PANEL LOCK] does not affect the remote control functions.
- How to release the [CONTROL PANEL LOCK]
 1. When the projector is projecting image or in the sleep mode, press and hold the INPUT button on the projector cabinet for about 10 seconds. The [CONTROL PANEL LOCK] will be released.
 2. When the projector is in the standby mode, press and hold the POWER button on the projector cabinet. It enables to power on the projector. After checking the projector is projecting image, perform the previous step 1.

TIP:

- When the [CONTROL PANEL LOCK] is turned on, a key lock icon [] will be displayed at the bottom right of the menu.

Enabling Security [SECURITY]

This feature turns on or off the [SECURITY] function.

Unless the correct keyword is entered, the projector cannot project an image. (→ page 49)

NOTE:

- Your setting will not be affected even when [RESET] is done from the menu.

Selecting Communication Speed [COMMUNICATION SPEED]

This feature sets the baud rate of the PC CONTROL port (D-Sub 9P). It supports data rates from 4800 to 38400 bps. The default is 38400 bps. Select the appropriate baud rate for your equipment to be connected (depending on the equipment, a lower baud rate may be recommended for long cable runs).

NOTE:

- Your selected communication speed will not be affected even when [RESET] is done from the menu.

Selecting the serial port [SERIAL PORT]

This sets which terminal on the projector will receive the serial control signals when operating the projector by remote control from a commercially available HDBaseT transmitter (control signals for turning the power on and off, etc.). There is no need to make this setting if not operating the projector by remote control (only sending video and audio).

PC CONTROL	Control signals (RS-232C serial communications) are received at the PC CONTROL terminal.
HDBaseT	The video/audio and control signals (RS-232C serial communications) are received at the Ethernet/HDBaseT port.

NOTE:

- When [HDBaseT] is set, the projector goes into the [SLEEP] mode regardless the setting for the standby mode (→ page 83) on the on-screen menu is [NORMAL] or [NETWORK STANDBY]. Based on this, the projector can be powered ON by an HDBaseT transmission device that is connected to the projector when the projector is in the standby mode. However, the standby mode setting cannot be changed when [HDBaseT] is set.
- While [HDBaseT] is set for the [SERIAL PORT], power consumption in the standby mode becomes not to satisfy the energy saving regulation.

TIP:

- When controlling the projector using the LAN port, this works with either setting.

Turning On or Off Remote Sensor [REMOTE SENSOR]

Set the remote control sensors on the projector's front and rear panels and the HDBaseT remote control sensor.

The options are: [FRONT/BACK], [FRONT], [BACK], and [HDBaseT].

TIP:

- If the remote control system does not function when direct sunlight or strong illumination strikes the remote control sensor of the projector, change another option.

Setting ID to the Projector [CONTROL ID]

You can operate multiple projectors separately and independently with the single remote control that has the [CONTROL ID] function. If you assign the same ID to all the projectors, you can conveniently operate all the projectors together using the single remote control. To do so, you have to assign an ID number to each projector.

CONTROL ID NUMBER	Select a number from 1 to 254 you wish to assign to your projector.
CONTROL ID	Select [OFF] to turn off the [CONTROL ID] setting and select [ON] to turn on the [CONTROL ID] setting.

NOTE:

- When [ON] is selected for [CONTROL ID], the projector cannot be operated by using the remote control that does not support the CONTROL ID function. (In this case the buttons on the projector cabinet can be used.)
- Your setting will not be affected even when [RESET] is done from the menu.
- Pressing and holding the ENTER button on the projector cabinet for 10 seconds will display the menu for canceling the Control ID.

Assigning or Changing the Control ID

1. Turn on the projector.
2. Press the ID SET button on the remote control.

The [CONTROL ID] screen will be displayed.

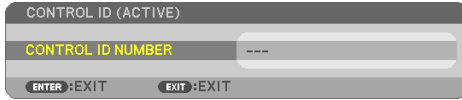

If the projector can be operated with the current remote control ID, the [CONTROL ID (ACTIVE)] will be displayed. If the projector cannot be operated with the current remote control ID, the [CONTROL ID (INACTIVE)] will be displayed. To operate the inactive projector, assign the [CONTROL ID] used for the projector by using the following procedure (Step 3).

3. Press one of numeric keypad buttons while pressing and holding the ID SET button on the remote control.

Example:

To assign "3", press the "3" button on the remote control.

No ID means that all the projectors can be operated together with a single remote control. To set "No ID" and cancel the control ID setting, enter "000" or press the number 0 while holding down the ID SET button.

TIP:

- The range of IDs is from 1 to 254.

4. Release the ID SET button.

The updated [CONTROL ID] screen will be displayed.

NOTE:

- The IDs can be cleared in a few days after the batteries are run down or removed.
- Accidentally pressing any one of the buttons of the remote control will clear currently specified ID with batteries removed.

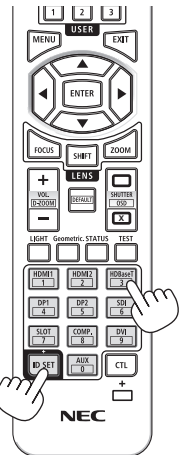
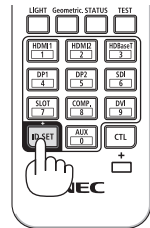

Using Test Pattern [TEST PATTERN]

Displays the test pattern for adjusting distortion on the screen and the focus at the time of the projector setup. Once the [TEST PATTERN] on the onscreen menu is selected, the pattern for adjustment will be displayed on. If you find distortion on the pattern, adjust the projector installation angle or correct distortion by pressing the Geometric. button on the remote. If the focus adjustment is required, control the focus lever. Recommend to perform the focus adjustment after leaving the projector under the state the TEST PATTERN has been projected for over 30 minutes. Press EXIT button to close the test pattern and return to the menu.

[INSTALLATION(2)]

Adjusting the white balance for all signals [REF. WHITE BALANCE]

This feature allows you to adjust the white balance for all signals.

The white and black levels of the signal are adjusted for optimum color reproduction.

CONTRAST R, CONTRAST G, CONTRAST B	These adjust the picture's white color.
BRIGHTNESS R, BRIGHTNESS G, BRIGHTNESS B	These adjust the picture's black color.

[LENS POSITION]

Set back the lens to the home position.

[LENS CALIBRATION]

The adjustment range of the zoom, focus, and shift of the mounted lens is calibrated.

Be sure to carry out [LENS CALIBRATION] after replacing the lens.

- This function is not available for the lens unit NP50ZL and NP44ML.

[OPTIONS(1)]**Switching the displayed image smoothly [SEAMLESS SWITCHING]**

When the input connector is switched, the image displayed before switching is held to switch to the new image without a break due to absence of a signal.

Selecting Fan Mode [FAN MODE]

[FAN MODE] is used to set the speed of the internal cooling fan.

AUTO	The built-in fans automatically run at a variable speed according to the internal temperature.
HIGH ALTITUDE	The built-in fans run at a high speed. Select this option when using the projector at altitudes approximately 5500 feet/1600 meters or higher.

NOTE:

- Set [FAN MODE] to [HIGH ALTITUDE] when using the projector at altitudes approximately 5500 feet/1600 meters or higher.
- Using the projector at altitudes approximately 5500 feet/1600 meters or higher without setting to [HIGH ALTITUDE] can cause the projector to overheat and the protector could shut down. If this happens, wait a couple minutes and turn on the projector.
- Using the projector at altitudes approximately 5500 feet/1600 meters or higher can shorten the life of optical components such as the light module.
- Your setting will not be affected even when [RESET] is done from the menu.

Enabling or Disabling WXGA Mode [WXGA MODE]

Selecting [ON] will give priority to WXGA (1280 × 768)/WUXGA (1920 × 1200) signals in recognizing an input signal.

When [WXGA MODE] is set to [ON], XGA (1024 × 768)/UXGA (1600 × 1200) signals may not be recognized. In this case, select [OFF].

NOTE:

- The [ON] is selected at the time of shipment.

Setting HDMI1, HDMI2, or HDBaseT [VIDEO LEVEL]

Make the settings for each video level when connecting HDMI equipment and Ethernet/HDBaseT terminal.

Select [AUTO] to automatically detect video level. If automatic detection may not work well, select [NORMAL] to disable the [ENHANCED] feature of your HDMI equipment or select [ENHANCED] to improve image contrast and increase detail in the dark areas.

[OPTIONS(2)]**Selecting Power-saving in [STANDBY MODE]**

Set the mode after turning off the power of the projector.

NORMAL	The projector will go into the standby mode, lowering the power consumption. The POWER indicator flashes in orange. When [NORMAL] is selected, only the following buttons and feature will work: POWER button on the projector cabinet and the remote control, powering on from PC Control command, and [AUTO POWER ON].	Power consumption: Low
NETWORK STANDBY	The projector goes into the network standby mode. The projector can be turned on using a wired LAN (LAN port). The POWER indicator lights up in orange. When [NETWORK STANDBY] is selected, only the following buttons, terminals, and features will work: POWER button on the projector cabinet and the remote control, powering on from PC Control command, [AUTO POWER ON], [NETWORK SERVICE].	Power consumption: Medium
SLEEP	The projector is maintained in the sleep mode. In addition to the buttons, terminals and functions that operate in the network standby mode, you can operate the projector with a HDBaseT-compatible transmission device connected to the Ethernet/HDBaseT port. POWER indicator lights up in green.	Power consumption: High

Important:

- When [NETWORK STANDBY] has been set for [STANDBY MODE] and the LAN has been in link-down condition for 3 minutes, [STANDBY MODE] will transit into [NORMAL] automatically for the purpose to save the consumption power.
- When [NETWORK STANDBY] is selected, [AUTO POWER OFF] will turn in grey and be disabled and [0:15] will be selected automatically for [AUTO POWER OFF].
- In the below conditions, setting of the [STANDBY MODE] is disabled and the projector will go into the SLEEP mode*.
 - * Sleep mode refers the mode without functional restrictions by the [STANDBY MODE].
 - When a temperature error or other error has occurred
 - [SERIAL PORT] is set to [HDBaseT]
 - [REMOTE SENSOR] is set to [HDBaseT]
 - [WIRED LAN] → [INTERFACE] is set to [HDBaseT]
 - While the lens is moving
 - When [STANDBY MODE] is in [NETWORK STANDBY] and the following settings occur
 - [NETWORK SERVICE] → [AMX BEACON] is enabled
 - [NETWORK SERVICE] → [Crestron Control] is enabled
 - [NETWORK SERVICE] → [Extron XTP] is enabled
 - [AUTO POWER ON] is set to something other than [OFF] and a signal is being input to the HDMI1 or HDMI2 terminal
 - When accessing the HTTP server

TIP:

- Even when [NORMAL] is selected for [STANDBY MODE], power on or off can be done by using the PC CONTROL port. However, in the [NORMAL] mode, ASCII CONTROL COMMAND cannot be used. When using ASCII CONTROL COMMAND, set it to [NETWORK STANDBY] or [SLEEP].
- The power consumption in the standby mode will not be included in calculating CO₂ emission reduction.
- Your setting will not be affected even when [RESET] is done from the menu.

Enabling Direct Power On [DIRECT POWER ON]

Turns the projector on automatically when the power cord is inserted into an active power outlet. This eliminates the need to always use the POWER button on the remote control or projector cabinet.

WARNING

- The projector produces intense light. When turning on the power, make sure no one within the projection range is looking at the lens.

Turning On the Projector By Applying Computer Signal [AUTO POWER ON]

When the projector is in Standby mode, applying a HDMI signal from a computer connected to the HDMI 1 IN, or HDMI 2 IN input will power on the projector and simultaneously project the image. This functionality eliminates the need to always use the POWER button on the remote control or the projector cabinet to power on the projector.

To use this function, first connect a computer to the projector and the projector to an active AC input.

OFF	The AUTO POWER ON function will not work.
AUTO	The projector's power turns on and the image is projected automatically when HDMI signals are detected. If more than one device is connected to the projector and the input signals cannot be detected correctly, select the input terminal (HDMI1 or HDMI2).
HDMI1	Signal detection is performed for the selected input terminal.
HDMI2	When a signal is detected, the projector's power turns on automatically and the image is projected.

WARNING

- The projector produces intense light. When turning on the power, make sure no one within the projection range is looking at the lens.

NOTE:

- To enable the [AUTO POWER ON] after changing to the sleep mode turning off the projector, wait 30 seconds and input a signal. If a signal is still present when the projector is turned off, the [AUTO POWER ON] will not work and the projector remains in standby mode.
- Depending on the projector in use, the [AUTO POWER ON] may not work properly. In this case, set [STANDBY MODE] to [NETWORK STANDBY].

Enabling Power Management [AUTO POWER OFF]

When this option is selected you can enable the projector to automatically turn off if there is no signal received by any input or if no operation is performed.

TIME		Set an interval between 1 and 60 minutes from when no signal is received until the unit enters standby mode.
MODE	OFF	The [AUTO POWER OFF] function will not operate.
	ON	The unit will switch off and enter standby mode if an input signal is not received after the time set in "Time".

TIP:

- [AUTO POWER OFF] can be set for each [STANDBY MODE].

The factory default times set for each mode are as follows.

	TIME	MODE
NORMAL	60	ON
NETWORK STANDBY	15	ON
SLEEP	5	OFF

- When the remaining time reaches 3 minutes before the projector is turned off, the [THE PROJECTOR WILL TURN OFF WITHIN 3 MINUTES.] message will be displayed on the bottom of the screen.

However, if you have selected "0:01", "0:02", or "0:03", when the remaining time reaches 30 seconds before the projector is turned off, the above message will be displayed.

Selecting Default Source [DEFAULT INPUT SELECT]

You can set the projector to default to any one of its inputs each time the projector is turned on.

LAST	Sets the projector to default to the previous or last active input each time the projector is turned on.
AUTO	Searches for an active source in order of [HDMI1] → [HDMI2] → [HDBaseT] and displays the first found source.
HDMI1	Displays the digital source from the HDMI 1 IN terminal every time the projector is turned on.
HDMI2	Displays the digital source from the HDMI 2 IN terminal every time the projector is turned on.
HDBaseT	Projects the signal transmitted from the terminals supported HDBaseT.

Adjusting the color shift of the screen [STATIC CONVERGENCE]

This features allows you to adjust for color deviation in the picture.

This can be adjusted in units of ± 1 pixel in the horizontal direction for [HORIZONTAL R], [HORIZONTAL G] and [HORIZONTAL B], in the vertical direction for [VERTICAL R], [VERTICAL G] and [VERTICAL B].

[NETWORK SETTINGS]

Configure the various settings when using the projector connected to a network.

When inputting characters for the [NETWORK PASSWORD] or other fields, use the projector's or remote control's ▲▼ buttons to select the alphanumeric characters and ◀▶ buttons to move the cursor.

Important:

- Consult with your network administrator about these settings.
- When using a wired LAN, connect the Ethernet cable (LAN cable) to the LAN port on the projector. (→ page 102)
- Please use a shielded twisted pair (STP) cable of Category 5e or higher for the LAN cable (sold commercially).
- The default [WIRED LAN] setting of this projector is set to [DISABLE] when it is shipped from the factory. To connect to a network, change the [WIRED LAN] profile setting from [DISABLE] to [ENABLE].

TIP:

- The network settings you make will not be affected even when [RESET] is done from the menu.
-

[NETWORK PASSWORD]

Setting a password when using a wired LAN. Alternatively, changing the set password.

Set the password using a maximum of up to 10 alphanumeric characters.

If a password is set, you need to enter the password in the following cases.

- When opening the [NETWORK PASSWORD] screen and [WIRED LAN] screen of the on-screen menu
- When updating the network settings on the [SETTINGS] screen of the HTTP server

To delete the set password, leave the password entry field blank when registering.

TIP:

- If you forget your password, consult with your dealer.
-

[WIRED LAN]

When you select [WIRED LAN] in the on-screen menu for the first time after purchasing the projector, the [NETWORK PASSWORD] setting screen will appear. Carry out the following Step (1) or Step (2).

(1) When setting the network password (recommended)

Refer to [NETWORK PASSWORD] (→ page 86).

(2) When no network password is set

Leave the input field in the [NETWORK PASSWORD] setting screen blank and press the ENTER button.

If [NETWORK PASSWORD] has been set, you cannot display the [WIRED LAN] screen without entering password.

INTERFACE	Select [LAN] for using the LAN port for connecting to the wired LAN. Select [HDBaseT] for using the Ethernet/HDBaseT port for connecting to the wired LAN.	—
PROFILE	Select [ENABLE] when connected to a wired LAN and [DISABLE] when not connected.	—
DHCP	ON: IP address, subnet mask, and gateway will be automatically assigned to the projector from your DHCP server. OFF: Specify IP address, subnet mask, and gateway assigned by your network administrator.	—
IP ADDRESS	Set your IP address of the network connected to the projector when [DHCP] is turned off.	Up to 12 numeric characters
SUBNET MASK	Set your subnet mask number of the network connected to the projector when [DHCP] is turned off.	Up to 12 numeric characters
GATEWAY	Set the default gateway of the network connected to the projector when [DHCP] is turned off.	Up to 12 numeric characters
AUTO DNS	ON: DHCP server will automatically assign IP address of DNS server connected to the projector. OFF: Set your IP address of DNS server connected to the projector.	Up to 12 numeric characters
DNS	Set the IP address of your DNS server on the network connected to the projector when [AUTO DNS] is cleared.	Up to 12 numeric characters
RECONNECT	Retry to connect the projector to a network. Try this if you have changed [PROFILE].	—

Enabling HTTP server [HTTP SERVER]

Select [ENABLE] when using the HTTP server function and [DISABLE] when not using it. The settings will be reflected the next time the projector is turned on.

4-6. Menu Descriptions & Functions [INFO.]

[USAGE TIME]

[LIGHT HOURS USED] (H)

[FILTER HOURS USED] (H)

[TOTAL CARBON SAVINGS] (kg-CO₂)

- [TOTAL CARBON SAVINGS]

This displays the estimated carbon saving information in kg. (→ page 42)

[SOURCE(1)]

[SOURCE NAME]

[HORIZONTAL FREQUENCY]

[SYNC POLARITY]

[SOURCE INDEX]

[VERTICAL FREQUENCY]

[SCAN TYPE]

[SOURCE(2)]

[SIGNAL TYPE]

[VIDEO LEVEL]

[BIT DEPTH]

[HDBaseT]

[SIGNAL QUALITY]

[LINK STATUS]

[OPERATION MODE]

[HDMI STATUS]

[WIRED LAN]

[IP ADDRESS]

[GATEWAY]

[SUBNET MASK]

[MAC ADDRESS]

[VERSION(1)]

[FIRMWARE] Version

[DATA] Version

[VERSION(2)]

[FIRMWARE2] Version

[FIRMWARE4] Version

[DATA2] Version

[OTHERS]

[PROJECTOR NAME]

[MODEL NO.]

[LENS ID]

[HOST NAME]

[SERIAL NUMBER]

[CONTROL ID] (when [CONTROL ID] is set)

[CONDITIONS]

[INTAKE TEMPERATURE]

[INSTALLATION POSITION]

[Y-AXIS]

[EXHAUST TEMPERATURE]

[X-AXIS]

[Z-AXIS]

About the [X-AXIS], [Y-AXIS], and [Z-AXIS] under [CONDITIONS]

* Arrow direction of the Z-AXIS in the figure represents the top of the projector.

X-AXIS:

Display the projector image at an angle of $-100 - +100$ degrees to the horizontal in the X-axis direction.

X-AXIS value of
the projector

Horizontal plane
X-axis

Gravity direction

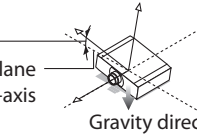

Y-AXIS:

Display the projector image at an angle of $-100 - +100$ degrees to the horizontal in the Y-axis direction.

Y-AXIS value of
the projector

Horizontal plane
Y-axis

Gravity direction

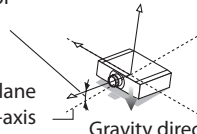

Z-AXIS:

Display the projector image at an angle of $-100 - +100$ degrees to the vertical in the Z-axis direction.

Z-AXIS value of
the projector

Horizontal
plane Z-axis

Gravity direction

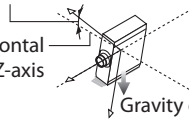

4-7. Menu Descriptions & Functions [RESET]

Returning to Factory Default [RESET]

The [RESET] feature allows you to change adjustments and settings to the factory preset for a (all) source(s) except the following:

[CURRENT SIGNAL]

Resets the adjustments for the current signal to the factory preset levels.

The items that can be reset are: [PRESET], [CONTRAST], [BRIGHTNESS], [COLOR], [HUE], [SHARPNESS], [ASPECT RATIO], and [OVERSCAN].

[ALL DATA]

Reset all the adjustments and settings for all the signals to the factory preset.

All items can be reset **EXCEPT** [KEYSTONE HORIZONTAL], [KEYSTONE VERTICAL], [PINCUSHION], [PC TOOL], [ADMINISTRATOR MODE], [LANGUAGE], [BACKGROUND], [FILTER MESSAGE], [ORIENTATION], [SECURITY], [COMMUNICATION SPEED], [SERIAL PORT], [CONTROL ID], [REF. WHITE BALANCE], [FAN MODE], [STANDBY MODE], [STATIC CONVERGENCE], [NETWORK SETTINGS], [LIGHT HOURS USED], [FILTER HOURS USED], [TOTAL CARBON SAVINGS], and [PROJECTOR NAME].

[CLEAR FILTER HOURS]

Resets the filter usage back to zero. Selecting this option displays submenu for a confirmation. Select [YES] and press the ENTER button.

The [OFF] item is selected for [FILTER MESSAGE] at the time of shipment. When [OFF] is selected, you do not need to clear the filter usage hour.

5. Attach the lens unit, accessories, etc.

5-1. Mounting a lens (sold separately)

Ten separate bayonet style lenses can be used with this projector. The descriptions here are for the NP13ZL (2x zoom) lens. Mount other lenses in the same manner.

Be sure to carry out [LENS CALIBRATION] after replacing the lens.

WARNING:

(1) Turn off the power and wait for the cooling fan to stop, (2) disconnect the power cord and wait for the unit to cool before mounting or removing the lens. Failure to do so can result in eye injury, electric shock, or burn injuries.

Important:

- The projector and lenses are made of precision parts. Do not subject them to shock or excessive forces.
- Remove the separately sold lens when moving the projector. If not, the lens could be subject to shock while the projector is being moved, damaging the lens and the lens shift mechanism.
- When dismantling the lens from the projector, return the lens position to the home position before turning off the power. Failure to do so may prevent the lens from being mounted or dismantled because of narrow space between the projector and the lens.
- Never touch the lens surface while the projector is operating.
- Be very careful not to let dirt, grease, etc., on the lens surface and not to scratch the lens surface.
- Perform these operations on a flat surface over a piece of cloth, etc., to prevent the lens from getting scratched.
- When leaving the lens off the projector for long periods of time, mount the dust cap on the projector to prevent dust or dirt from getting inside.
- Always use the included support kit to secure the projector body and lens unit after affixing the NP50ZL. Please refer to the NP50ZL Installation Manual for details.
- Always use the support kit (NP01LK, sold separately) to secure the projector body and lens unit after affixing the NP44ML. Please refer to the support kit's Instruction Manual for details.

Mounting the lens

1. Remove the dust cap from the projector.

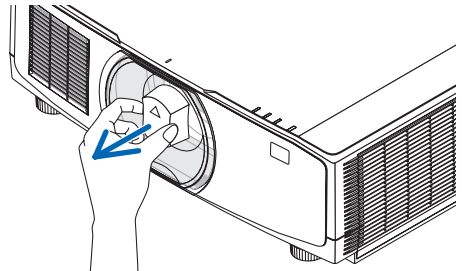

5. Attach the lens unit, accessories, etc.

2. Remove the lens cap on the back of the lens.

NOTE:

- Make sure to remove the lens cap at the unit back side. If the lens unit with the lens cap remaining on is installed on the projector, it may cause of malfunction.

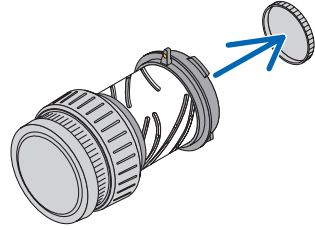

3. Align the protrusion on the lens with the guiding notch on the projector lens hole and insert the lens.

NP11FL/NP12ZL/NP13ZL/NP14ZL/NP15ZL:

- Each protrusion is marked in yellow.

NP40ZL/NP41ZL/NP43ZL/NP50ZL/NP44ML:

- The arrow mark in the label attached to the lens shows the position of protrusion.

Insert the lens slowly all the way in.

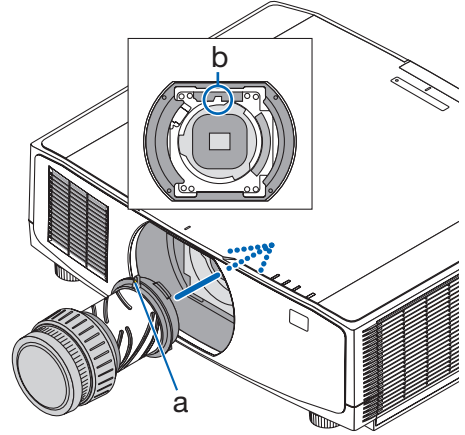

a: Protrusion / b: Guiding notch

4. Turn the lens clockwise.

NOTE:

- Do not press the lens release button at the bottom of the lens mounting section when attaching the lens unit. You will not be able to fix the lens unit in the correct position.

Turn until a click is heard.

The lens is now fastened onto the projector.

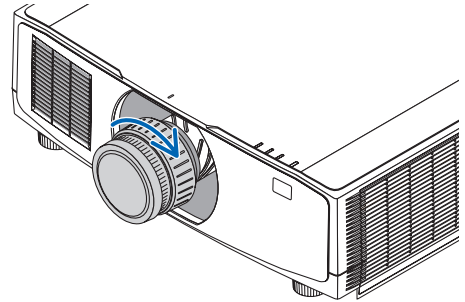

5. Attach the lens unit, accessories, etc.

5. Mount the lens theft prevention screw.

Fasten the lens theft prevention screw included with the projector to the bottom of the projector so that the lens cannot be removed easily.

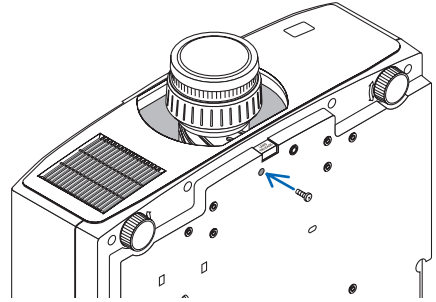

Removing the lens

Preparations:

1. Turn on the projector and display an image.
2. Press and hold the SHIFT/HOME POSITION button over 2 seconds.
The lens position will be moved to the home position.
3. Turn off the main power switch, and then unplug the power cord.
4. Wait until the projector cabinet is cool enough to handle.

1. Remove the lens theft prevention screw.

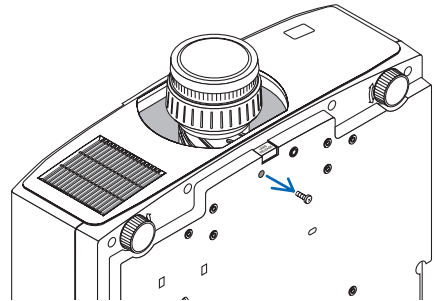

5. Attach the lens unit, accessories, etc.

2. While pressing the lens release button at the bottom of lens mounting section on the projector's front panel fully in, turn the lens counterclockwise.

The lens comes off.

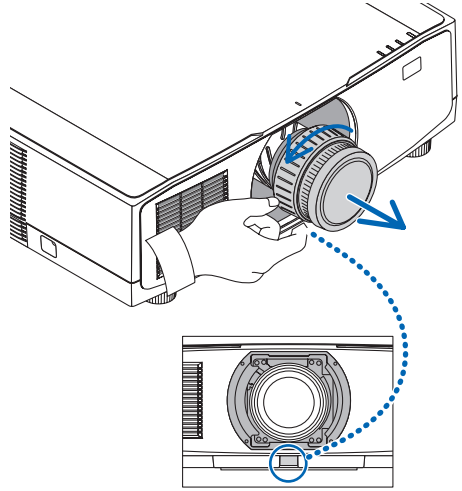

3. Slowly pull the lens off the projector.

- After removing the lens, mount the lens caps (front and back) included with the lens before storing the lens.
- If no lens is going to be mounted on the projector, mount the dust cap included with the projector.

Make sure the direction to mount the dust cap to face the distinguish mark (Δ) on the cap upward.

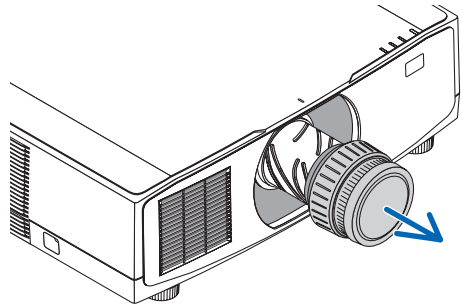

5-2. Attaching the strap (supplied)

Attaching the strap to the filter cover prevents the strap from falling when the projector is suspended from the ceiling.

Preparation:

Remove the filter cover from the projector.

Refer to the clause "7-3. Cleaning the Filters" on page 105 about the filter cover installation.

1. **Insert the round protrusion at the filter cover strap end (resinoid strap) to the hole on the filter cover.**

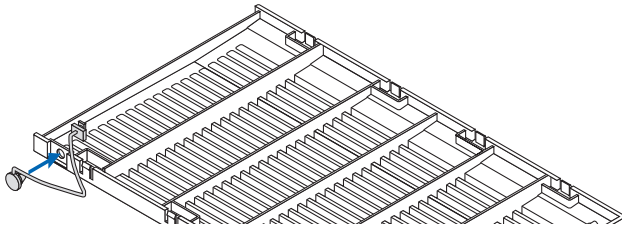

2. **Insert the square protrusion at the opposite end of the filter cover strap to the hole on the projector body and rotate the strap 90° for fixation. It becomes easier to fix the strap if you remove the filter once.**

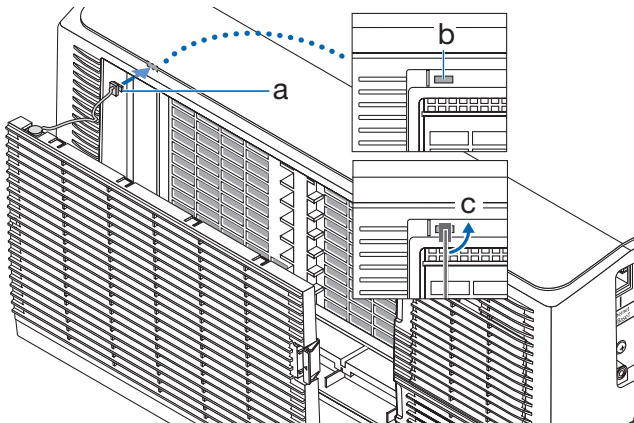

a: Square protrusion / b: Hole for fixing the strap / c: Rotate the strap 90°

5-3. Attaching the power cord stopper (supplied)

To prevent the power cord from accidentally removing from the AC IN of the projector, use the power cord stopper.

⚠ CAUTION:

To prevent the power cord from coming loose, make sure that all the prongs of the power cord are fully inserted into the AC IN terminal of the projector before using the power cord stopper to fix the power cord. A loose contact of the power cord may cause a fire or electric shock.

NOTE:

- If you pull on the power cord while the connector is fixed, the main unit may fall down and be damaged.

The power cord stopper is consisted from the part (a) that should be installed on the projector and the part (b) that should be installed on the power cord.

1. Fix the part (a) to the AC IN terminal on the projector cabinet.

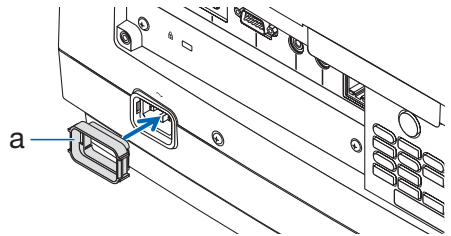

2. Fix the part (b) to the power cord.

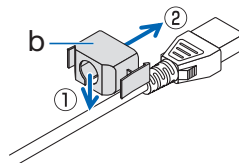

3. Insert the power cord plug to the AC IN terminal until the power cord stopper is fastened completely and click sound is heard.

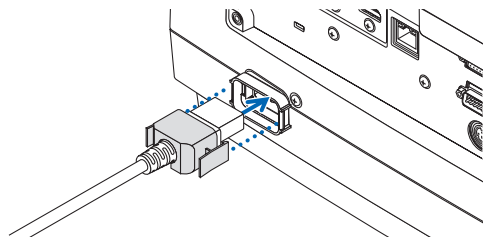

5-4. Mounting the cable cover (sold separately)

Mounting the separately sold cable cover on the projector allows you hide the cables for a cleaner appearance.

NP10CV for PV800UL-W/PV710UL-W

NP10CV-B for PV800UL-B/PV710UL-B

CAUTION

- After mounting the cable cover, be sure to fasten using the screws provided. If not, the cable cover could fall and damage the cable cover and possibly resulting in injury.
- Do not bundle the power cord and place it under the cable cover. Doing so could lead to fire.
- Do not hold the cable cover while moving the projector and do not apply excessive force to the cable cover. Doing so could damage the cable cover, resulting in the projector falling or causing injury.

Mounting

Preparations:

1. Connect the power cord and cables to the projector (the connection cords are omitted from the diagrams).
2. Prepare a Phillips screwdriver.

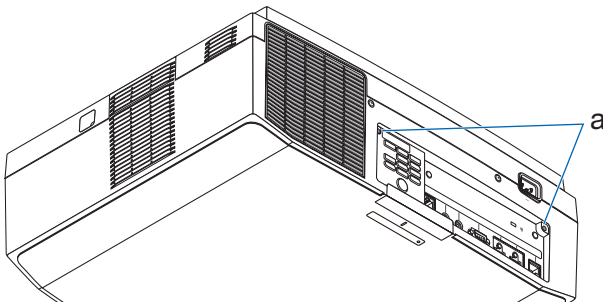

a: Screw holes for the cable cover

5. Attach the lens unit, accessories, etc.

1. Insert the two round protrusions on the left and right edges of the cable cover into the grooves in the bottom of the projector to line it up.

NOTE:

- Be careful not to let the power cord and cables get pinched by the cable cover.

2. Turn the cable cover screw clockwise.

- Tighten the screw securely.

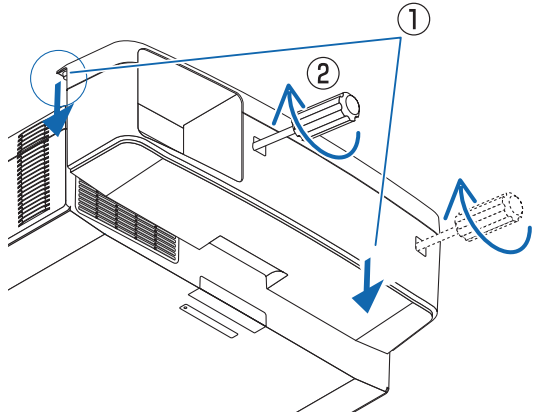

Removing

1. Turn the cable cover screw counter-clockwise until it turns loosely.

- Hold the cable cover while doing this to prevent it from falling.
- The screw does not come completely off.

2. Remove the cable cover.

- Turn the cable cover a little, then lift it off.

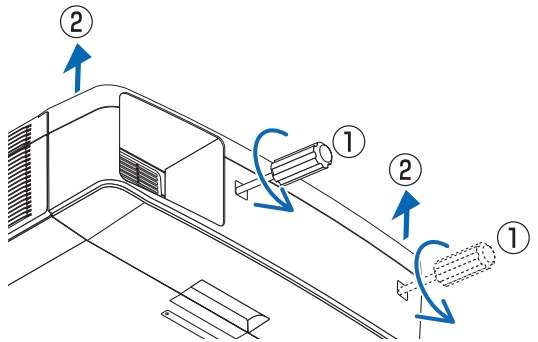

6. Connecting to Other Equipment

CAUTION

- Be sure to turn off the projector before connecting the projector to an external device. If projected light enters your eyes, it may cause visual impairment.

NOTE:

- The connection cable is not enclosed with the projector. Please get ready a suitable cable for the connection.
For HDMI, LAN, RS-232C, and AUDIO, please use a shielded signal cable.
Use of other cables and adapters may cause interference with radio and television reception.

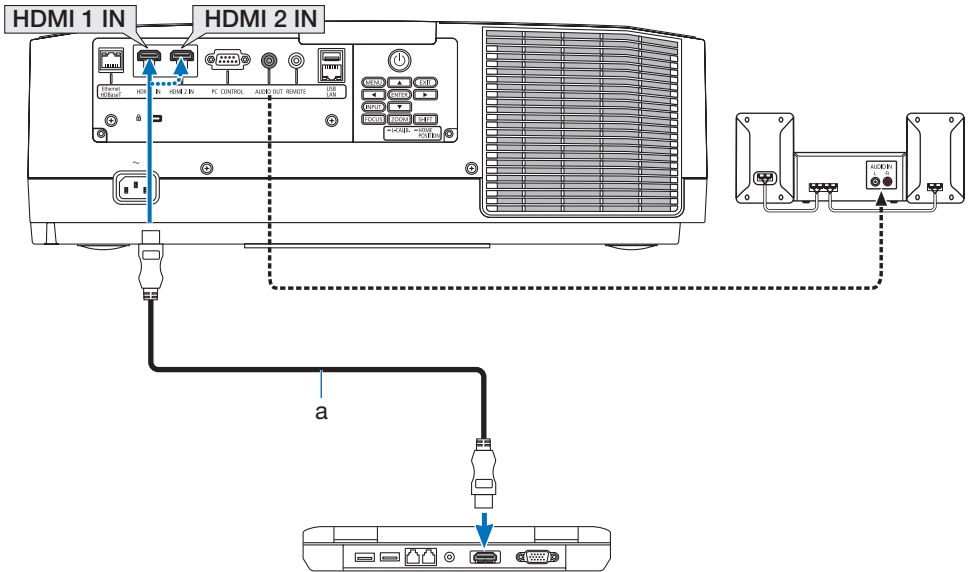

6-1. Connecting Your Computer

- Connect a commercially available HDMI cable between the computer's HDMI output connector and the projector's HDMI 1 IN or HDMI 2 IN connector.



a: HDMI cable (not supplied)

- Select the source name for its appropriate input connector after turning on the projector.

Input connector	INPUT button on the projector cabinet	Button on the remote control
HDMI 1 IN	 HDMI1	HDMI1
HDMI 2 IN	 HDMI2	HDMI2

Cautions when connecting an HDMI cable



- Use a certified High Speed HDMI® Cable.

6-2. Connecting audio video equipment

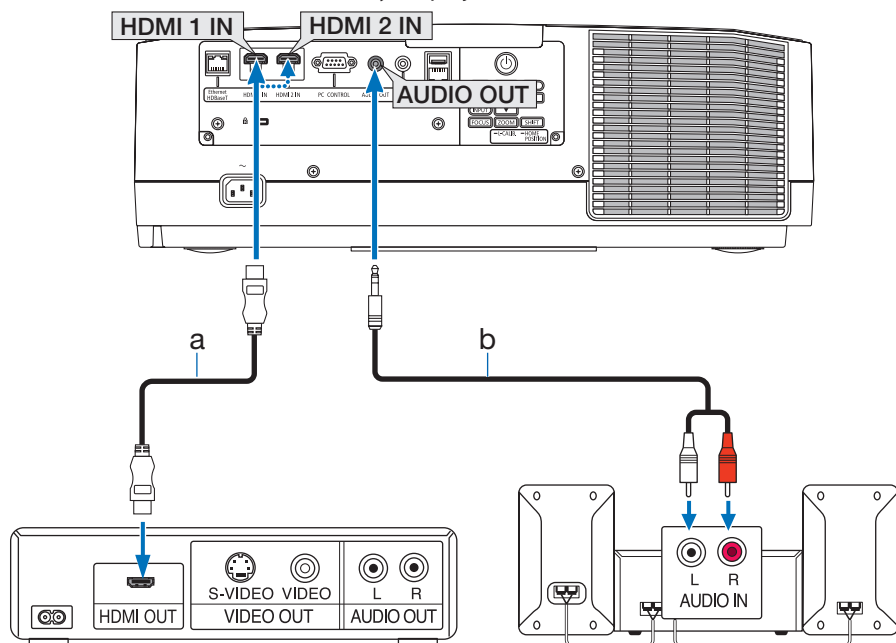
You can connect the HDMI output of your Blu-ray player, hard disk player, or notebook type PC to the HDMI 1 IN or HDMI 2 IN connector of your projector.



a: HDMI cable (not supplied) (Use High Speed HDMI® Cable.) / b: Audio cable (not supplied)

Input connector	INPUT button on the projector cabinet	Button on the remote control
HDMI 1 IN	 HDMI1	HDMI1
HDMI 2 IN	 HDMI2	HDMI2

TIP:

- For users of audio video equipment with an HDMI connector:
Select "Enhanced" rather than "Normal" if HDMI output is switchable between "Enhanced" and "Normal".
This will provide improved image contrast and more detailed dark areas.
For more information on settings, refer to the instruction manual of the audio video equipment to be connected.
- When connecting the HDMI 1 IN or HDMI 2 IN connector of the projector to the Blu-ray player, the projector's video level can be made settings in accordance with the Blu-ray player's video level. In the menu select [ADJUST] → [VIDEO] → [VIDEO LEVEL] and make necessary settings.

6-3. Connecting to a HDBaseT transmission device (sold commercially)

Use a LAN cable sold commercially to connect the Ethernet/HDBaseT port of the projector (RJ-45) to a HDBaseT transmission device sold commercially.

The Ethernet/HDBaseT port of the projector supports HDMI signals (HDCP) from transmission devices, control signals from external devices (serial, LAN) and remote control signals (IR commands).

- Refer to the owner's manual accompanied with your HDBaseT transmission for connecting with your external devices.

Connection example

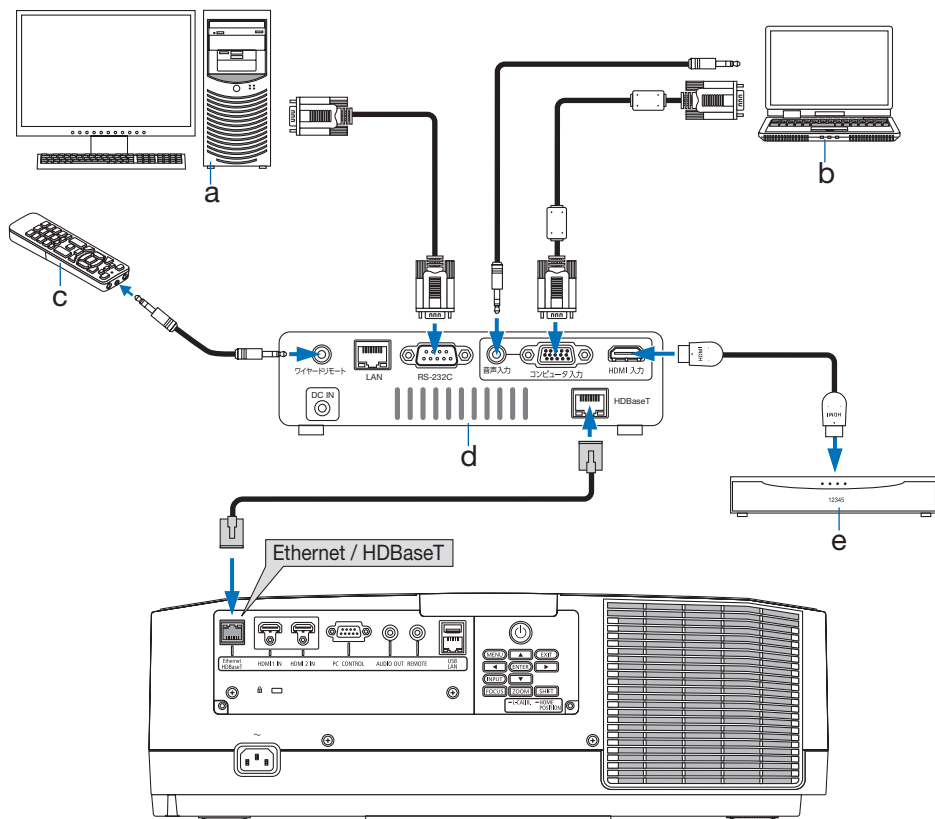

a: Computer (for control use) / b: Computer (for output use) / c: Remote control /
d: Example of a transmission device / e: HDMI output video device

NOTE:

- Please use a shielded twisted pair (STP) cable of Category 5e or higher for the LAN cable (sold commercially).
- The maximum transmission distance over the LAN cable is 100 m.
- Please do not use other transmission equipment between the projector and transmission equipment. The picture quality may be degraded as a result.
- This projector is not guaranteed to work with all HDBaseT transmission devices sold commercially.

6-4. Connecting to a Wired LAN

The projector comes standard with a LAN port (RJ-45) which provides a LAN connection using a LAN cable.

To use a LAN connection, you are required to set the LAN on the projector menu. Select [SETUP] → [NETWORK SETTINGS] → [WIRED LAN]. (→ page 87).

Example of LAN connection

Example of wired LAN connection

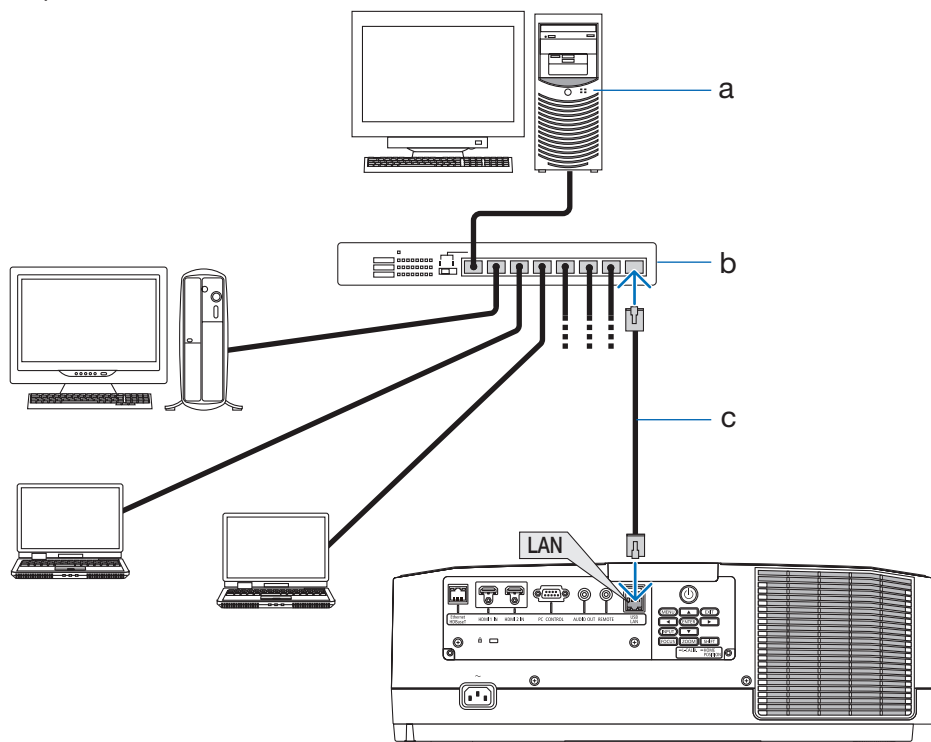

a: Server / b: Hub / c: LAN cable (not supplied) (Use a Category 5 or higher LAN cable.)

7. Maintenance

WARNING

- Please do not use a spray containing flammable gas to remove dust attached to the lens and cabinet. Doing so may result in fires.
- Turn off the power, unplug the power plug from the socket and remove the lens for cleaning. If the unit turns on while cleaning the lens, the strong light from the lens could damage your eyes. It could also burn your fingers.

7-1. Cleaning the Lens

- The projector has a plastic lens. Use a commercially available plastic lens cleaner.
- Do not scratch or mar the lens surface as a plastic lens is easily scratched.
- Never use alcohol or glass lens cleaner as doing so will cause damage to the plastic lens surface.

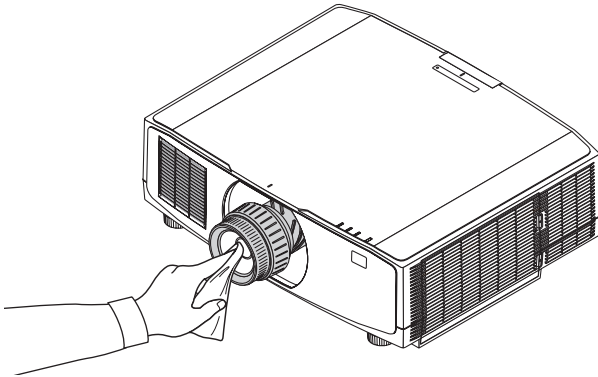

7-2. Cleaning the Cabinet

Turn off the projector, and unplug the projector before cleaning.

- Use a dry soft cloth to wipe dust off the cabinet.
If heavily soiled, use a mild detergent.
- Never use strong detergents or solvents such as alcohol or thinner.
- When cleaning the ventilation slits using a vacuum cleaner, do not force the brush of the vacuum cleaner into the slits of the cabinet.

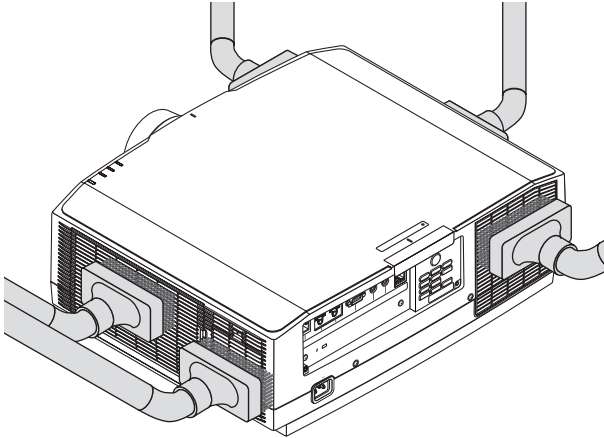

Vacuum the dust off the ventilation slits.

- Clogged ventilation slits may cause a rise in the internal temperature of the projector, resulting in malfunction.
- Do not scratch or hit the cabinet with your fingers or any hard objects
- Contact your dealer for cleaning the inside of the projector.

NOTE:

- Do not apply volatile agent such as insecticide on the cabinet, the lens, or the screen. Do not leave a rubber or vinyl product in prolonged contact with it. Otherwise the surface finish will be deteriorated or the coating may be stripped off.
-

7-3. Cleaning the Filters

The filter at the intake vent keeps dust and dirt from getting inside the projector. If the filter is dirty or clogged, your projector may overheat.

WARNING

- Please do not use a spray containing flammable gas to remove dust attached to the filters, etc. Doing so may result in fires.

NOTE:

- The message for filter cleaning will be displayed for one minute after the projector is turned on or off. When the message is displayed, clean the filters. The time to clean the filters is set to [OFF] at time of shipment. (→ page 76)
To cancel the message, press any button on the projector cabinet or the remote control.

To clean the filter, detach the filter unit and the filter cover.

CAUTION

- Before cleaning the filters, turn off the projector, disconnect the power cord and then allow the cabinet to cool. Failure to do so can result in electric shock or burn injuries.

- 1. Press down two buttons and then pull the filter cover towards you to open it.**

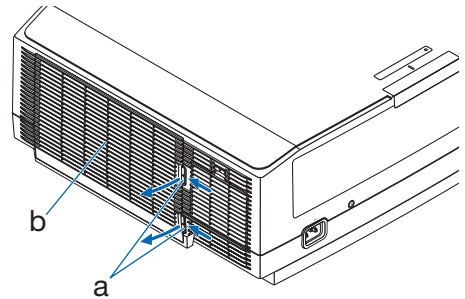

a: Button / b: Filter cover

2. Pick the center of the filter unit for pulling it out.

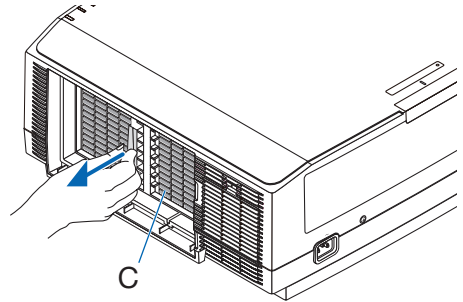

3. Vacuum dust on the front and back faces of the filter unit.

- Get rid of dust in the filter.
- Gently get rid of dust on the filter cover and in the accordion pleats of the filter.

NOTE:

- Whenever you vacuum the filter, use the soft brush attachment to vacuum. This is to avoid damage to the filter.
- Do not wash the filter with water. Doing so can result in filter clogging.

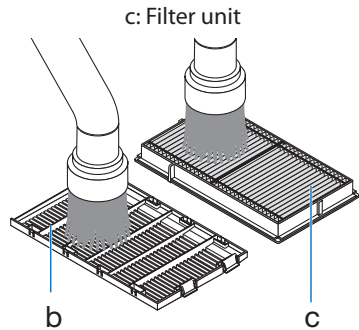

b: Filter cover / c: Filter unit

4. Mount the filter unit back onto the projector cabinet.

Insert the filter unit onto the projector aligning the two protrusions on each top and bottom of the filter unit to the grooves on the projector cabinet.

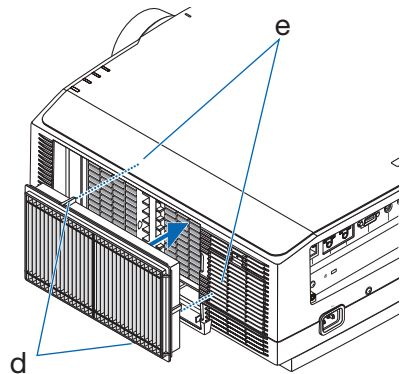

d: Protrusion / e: Groove

5. Close the filter cover.

Keep to push the filter cover frame around the buttons until a “click” sound is heard. The filter cover will be secured in position.

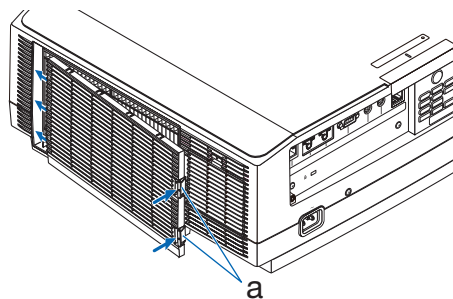

a: Button

Next, clean the intake vent on the filter side.

6. Hold down the button on the intake vent cover and gently pull the cover towards you to remove it

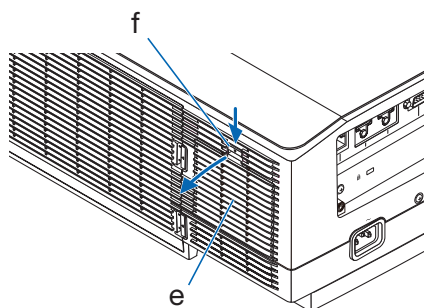

e: Intake vent cover / f: Button

7. Use a vacuum cleaner to remove dust from the intake vent cover and metal component.

- Use a soft, dry cloth to wipe away any dust that could not be removed with a vacuum cleaner.

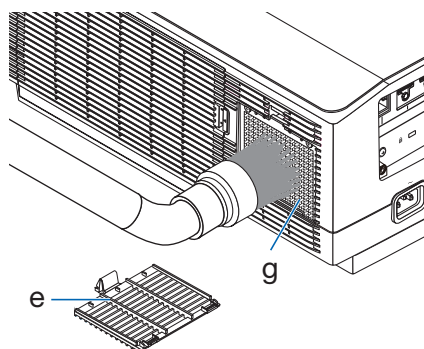

e: Intake vent cover / g: Metal component

8. Close the intake vent cover.

Keep to push the intake vent cover around the button until a “click” sound is heard. The intake vent cover will be secured in position.

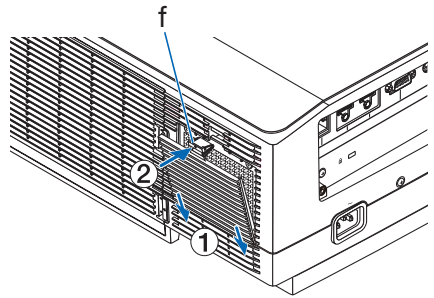

f: Button

9. Clear the filter usage hours.

Plug the power cord into the wall outlet, and then turn on the projector.

From the menu, select [RESET] → [CLEAR FILTER HOURS]. (→ page 90)

The interval time to clean the filters is set to [OFF] at time of shipment. When using the projector as it is, you do not clear the filter usage

7-4. Replacing the filters

Replace the filter every 10000 used hours.

Usable time of the filter is varies depends on the projector installation circumstances. If your projector is installed in dusty circumstance, recommend to replace the filter earlier than 10000 hours.

- The replacement filter, NP06FT, is available at our dealers.

CAUTION

- Before replacing the filters, turn off the projector, disconnect the power cord and then allow the cabinet to cool. Failure to do so can result in electric shock or burn injuries.

To replace the filters:

NOTE:

- Before replacing the filters, wipe off dust and dirt from the projector cabinet.
- The projector is precision equipment. Keep out dust and dirt during filter replacement.
- Do not wash the filters with soap and water. Soap and water will damage the filter membrane.
- Put filters into place. Incorrect attachment of a filter may cause dust and dirt to get into the inside of the projector.

- 1. Press down two buttons and then pull the filter cover towards you to open it.**

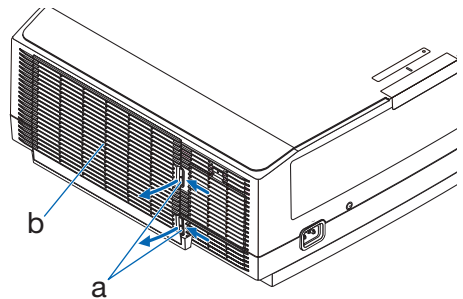

a: Button / b: Filter cover

- 2. Pick the center of the filter unit for pulling it out.**

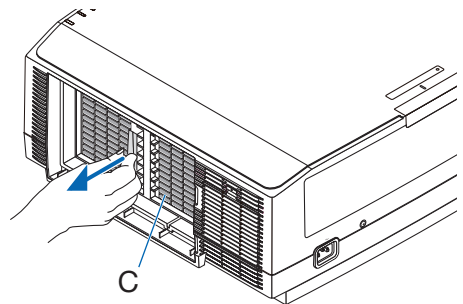

c: Filter unit

3. Remove dust from the filter cover.

Clean both outside and inside.

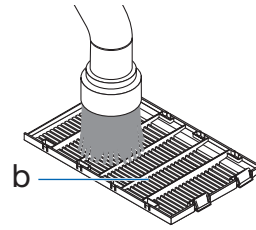

b

4. Mount a new filter unit onto the projector cabinet.

Insert the filter unit onto the projector aligning the two protrusions on each top and bottom of the filter unit to the groove on the projector cabinet.

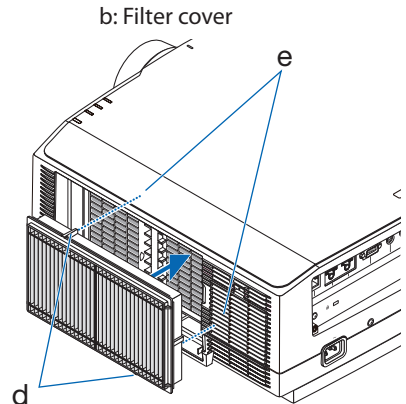

b: Filter cover

d

e

d: Protrusion / e: Groove

5. Close the filter cover.

Keep to push the filter cover frame around the buttons until a "click" sound is heard. The filter cover will be secured in position.

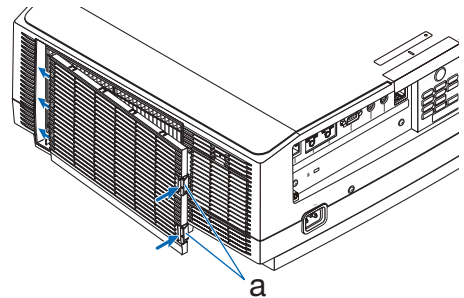

a

a: Button

**This completes the filter replacement.
Go on to clear the filter hours.**

To clear the filter hours:

1. **Place the projector where you use it.**
2. **Plug the power cord into the wall outlet, and then turn on the projector.**
3. **Clear the filter hours.**

From the menu, select [RESET] → [CLEAR FILTER HOURS] and reset the filter usage hours. (→ page 90)

8. Appendix

8-1. Throw distance and screen size

Ten separate bayonet style lenses can be used on this projector. Refer to the information on this page and use a lens suited for the installation environment (screen size and throw distance).

Projection range for the different lenses

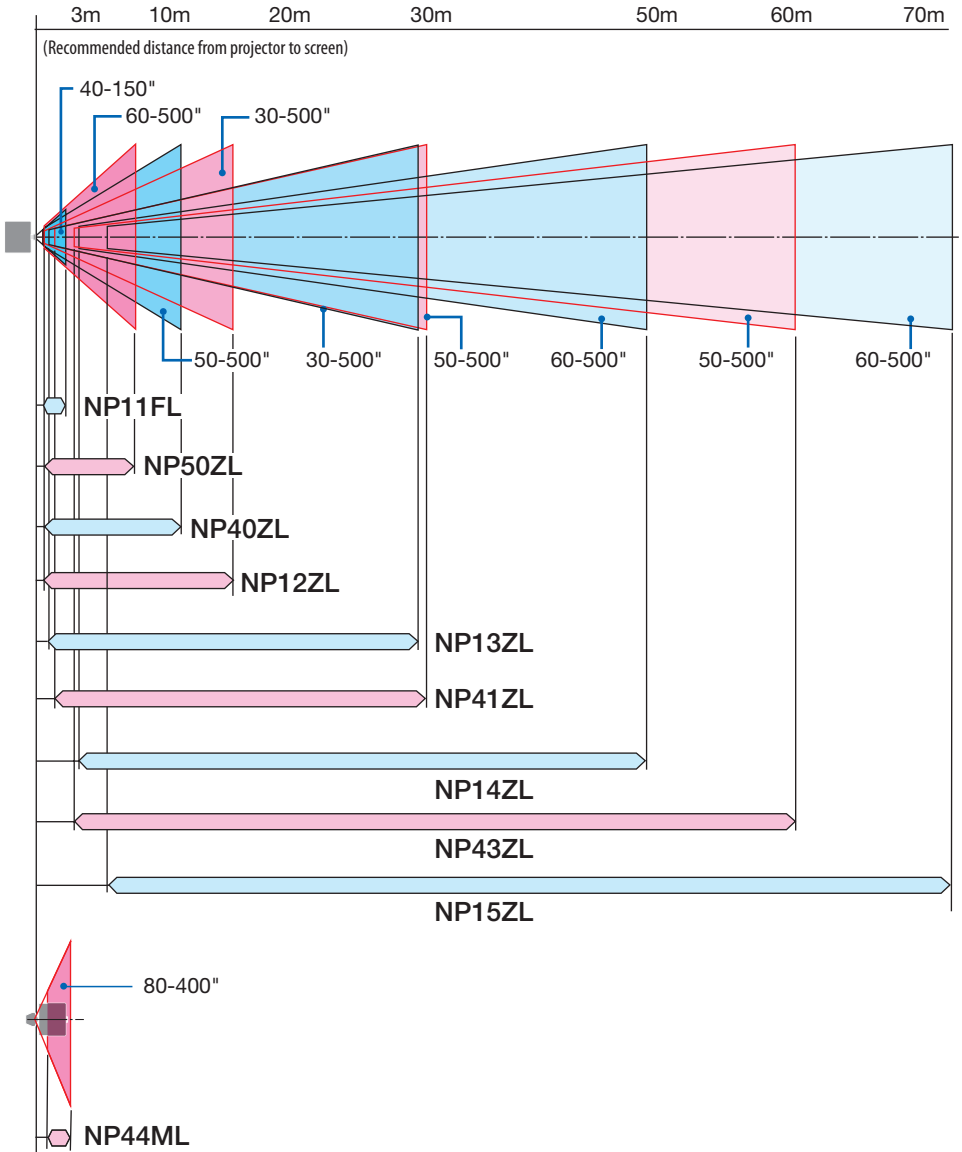

Lens types and throw distance (Aspect ratio 16:10)

(Unit: inch)

Screen size		Lens model name and throw distance				
	Width × Height (inches)	NP11FL	NP12ZL	NP13ZL	NP14ZL	NP15ZL
30	25 × 16	—	28 – 37	36 – 74	—	—
40	34 × 21	26	38 – 50	48 – 99	—	—
50	42 × 26	33	48 – 64	61 – 124	—	—
60	51 × 32	40	59 – 77	74 – 149	146 – 236	231 – 354
80	68 × 42	53	79 – 103	99 – 200	196 – 317	310 – 475
100	85 × 53	67	99 – 129	124 – 250	246 – 397	389 – 596
120	102 × 64	81	119 – 155	149 – 300	296 – 477	469 – 716
150	127 × 79	101	149 – 194	187 – 376	372 – 598	588 – 897
200	170 × 106	—	199 – 259	250 – 502	497 – 799	786 – 1199
240	204 × 127	—	239 – 312	301 – 602	598 – 959	945 – 1440
300	254 × 159	—	300 – 390	377 – 754	748 – 1200	1183 – 1802
400	339 × 212	—	400 – 521	503 – 1005	1000 – 1602	1580 – 2406
500	424 × 265	—	501 – 651	629 – 1257	1251 – 2004	1977 – 3009

Screen size		Lens model name and throw distance				
	Width × Height (inches)	NP40ZL	NP41ZL	NP43ZL	NP50ZL	NP44ML
30	25 × 16	—	—	—	—	(*)
40	34 × 21	—	—	—	—	
50	42 × 26	33 – 46	54 – 127	129 – 254	—	
60	51 × 32	40 – 56	66 – 153	154 – 303	30 – 38	
80	68 × 42	53 – 75	88 – 204	204 – 403	41 – 51	
100	85 × 53	67 – 94	110 – 256	254 – 503	51 – 64	
120	102 × 64	81 – 113	133 – 307	303 – 602	62 – 77	
150	127 × 79	101 – 142	166 – 384	378 – 752	78 – 97	
200	170 × 106	135 – 190	223 – 513	502 – 1001	104 – 130	
240	204 × 127	163 – 229	267 – 616	601 – 1201	126 – 156	
300	254 × 159	204 – 286	335 – 770	750 – 1500	157 – 196	
400	339 × 212	272 – 382	447 – 1028	999 – 1998	211 – 262	
500	424 × 265	340 – 478	559 – 1285	1247 – 2497	264 – 328	

(*) See page 120 for NP44ML.

(Unit: m)

Screen size		Lens model name and throw distance				
	Width × Height (cm)	NP11FL	NP12ZL	NP13ZL	NP14ZL	NP15ZL
30	64.6 × 40.4	—	0.7 – 0.9	0.9 – 1.9	—	—
40	86.2 × 53.8	0.7	1.0 – 1.3	1.2 – 2.5	—	—
50	107.7 × 67.3	0.8	1.2 – 1.6	1.6 – 3.1	—	—
60	129.2 × 80.8	1.0	1.5 – 1.9	1.9 – 3.8	3.7 – 6.0	5.9 – 9.0
80	172.3 × 107.7	1.4	2.0 – 2.6	2.5 – 5.1	5.0 – 8.0	7.9 – 12.1
100	215.4 × 134.6	1.7	2.5 – 3.3	3.2 – 6.3	6.3 – 10.1	9.9 – 15.1
120	258.5 × 161.5	2.1	3.0 – 3.9	3.8 – 7.6	7.5 – 12.1	11.9 – 18.2
150	323.1 × 201.9	2.6	3.8 – 4.9	4.8 – 9.5	9.4 – 15.2	14.9 – 22.8
200	430.8 × 269.2	—	5.1 – 6.6	6.4 – 12.7	12.6 – 20.3	20.0 – 30.5
240	516.9 × 323.1	—	6.1 – 7.9	7.6 – 15.3	15.2 – 24.4	24.0 – 36.6
300	646.2 × 403.9	—	7.6 – 9.9	9.6 – 19.1	19.0 – 30.5	30.1 – 45.8
400	861.6 × 538.5	—	10.2 – 13.2	12.8 – 25.5	25.4 – 40.7	40.1 – 61.1
500	1077.0 × 673.1	—	12.7 – 16.5	16.0 – 31.9	31.8 – 50.9	50.2 – 76.4

Screen size		Lens model name and throw distance				
	Width × Height (cm)	NP40ZL	NP41ZL	NP43ZL	NP50ZL	NP44ML
30	64.6 × 40.4	—	—	—	—	(*)
40	86.2 × 53.8	—	—	—	—	
50	107.7 × 67.3	0.8 – 1.2	1.4 – 3.2	3.3 – 6.4	—	
60	129.2 × 80.8	1.0 – 1.4	1.7 – 3.9	3.9 – 7.7	0.8 – 1.0	
80	172.3 × 107.7	1.4 – 1.9	2.2 – 5.2	5.2 – 10.2	1.0 – 1.3	
100	215.4 × 134.6	1.7 – 2.4	2.8 – 6.5	6.4 – 12.8	1.3 – 1.6	
120	258.5 × 161.5	2.0 – 2.9	3.4 – 7.8	7.7 – 15.3	1.6 – 2.0	
150	323.1 × 201.9	2.6 – 3.6	4.2 – 9.8	9.6 – 19.1	2.0 – 2.5	
200	430.8 × 269.2	3.4 – 4.8	5.7 – 13.0	12.7 – 25.4	2.6 – 3.3	
240	516.9 × 323.1	4.1 – 5.8	6.8 – 15.6	15.3 – 30.5	3.2 – 4.0	
300	646.2 × 403.9	5.2 – 7.3	8.5 – 19.6	19.1 – 38.1	4.0 – 5.0	
400	861.6 × 538.5	6.9 – 9.7	11.4 – 26.1	25.4 – 50.8	5.3 – 6.7	
500	1077.0 × 673.1	8.6 – 12.1	14.2 – 32.6	31.7 – 63.4	6.7 – 8.3	

(*) See page 120 for NP44ML.

Lens types and throw distance (Aspect ratio 16:9)

(Unit: inch)

Screen size	Width × Height (inches)	Lens model name and throw distance				
		NP11FL	NP12ZL	NP13ZL	NP14ZL	NP15ZL
30	26 × 15	—	29 – 39	37 – 76	—	—
40	35 × 20	27	40 – 52	50 – 102	—	—
50	44 × 25	34	50 – 65	63 – 127	—	—
60	52 × 29	41	60 – 79	76 – 153	150 – 243	237 – 364
80	70 × 39	55	81 – 106	102 – 205	202 – 325	319 – 488
100	87 × 49	69	101 – 132	128 – 257	253 – 408	400 – 612
120	105 × 59	83	122 – 159	154 – 309	305 – 491	482 – 737
150	131 × 74	104	153 – 200	193 – 386	382 – 615	604 – 923
200	174 × 98	—	205 – 267	257 – 516	511 – 821	808 – 1233
240	209 × 118	—	246 – 320	309 – 619	615 – 986	971 – 1481
300	261 × 147	—	308 – 401	387 – 775	769 – 1234	1216 – 1853
400	349 × 196	—	411 – 535	517 – 1033	1027 – 1647	1624 – 2473
500	436 × 245	—	515 – 670	646 – 1292	1286 – 2060	2032 – 3093

Screen size	Width × Height (inches)	Lens model name and throw distance				
		NP40ZL	NP41ZL	NP43ZL	NP50ZL	NP44ML
30	26 × 15	—	—	—	—	(*)
40	35 × 20	—	—	—	—	
50	44 × 25	34 – 48	56 – 131	133 – 260	—	
60	52 × 29	41 – 58	67 – 157	158 – 312	31 – 39	
80	70 × 39	55 – 77	90 – 210	209 – 414	42 – 52	
100	87 × 49	69 – 97	114 – 263	260 – 517	53 – 66	
120	105 × 59	83 – 117	137 – 316	312 – 619	64 – 79	
150	131 × 74	104 – 146	171 – 395	388 – 773	80 – 100	
200	174 × 98	139 – 196	229 – 527	516 – 1029	107 – 134	
240	209 × 118	167 – 235	275 – 633	618 – 1234	129 – 161	
300	261 × 147	209 – 294	344 – 792	771 – 1541	162 – 202	
400	349 × 196	280 – 393	459 – 1056	1026 – 2054	216 – 269	
500	436 × 245	350 – 491	575 – 1321	1282 – 2566	271 – 337	

(*) See page 121 for NP44ML.

(Unit: m)

Screen size		Lens model name and throw distance				
	Width × Height (cm)	NP11FL	NP12ZL	NP13ZL	NP14ZL	NP15ZL
30	66.4 × 37.4	—	0.7 – 1.0	0.9 – 1.9	—	—
40	88.6 × 49.8	0.7	1.0 – 1.3	1.3 – 2.6	—	—
50	110.7 × 62.3	0.9	1.3 – 1.7	1.6 – 3.2	—	—
60	132.8 × 74.7	1.0	1.5 – 2.0	1.9 – 3.9	3.8 – 6.2	6.0 – 9.3
80	177.1 × 99.6	1.4	2.1 – 2.7	2.6 – 5.2	5.1 – 8.3	8.1 – 12.4
100	221.4 × 124.5	1.8	2.6 – 3.4	3.2 – 6.5	6.4 – 10.4	10.2 – 15.6
120	265.7 × 149.4	2.1	3.1 – 4.0	3.9 – 7.8	7.7 – 12.5	12.2 – 18.7
150	332.1 × 186.8	2.6	3.9 – 5.1	4.9 – 9.8	9.7 – 15.6	15.4 – 23.4
200	442.8 × 249.1	—	5.2 – 6.8	6.5 – 13.1	13.0 – 20.9	20.5 – 31.3
240	531.3 × 298.9	—	6.3 – 8.1	7.9 – 15.7	15.6 – 25.0	24.7 – 37.6
300	664.1 × 373.6	—	7.8 – 10.2	9.8 – 19.7	19.5 – 31.3	30.9 – 47.1
400	885.5 × 498.1	—	10.4 – 13.6	13.1 – 26.3	26.1 – 41.8	41.3 – 62.8
500	1106.9 × 622.6	—	13.1 – 17.0	16.4 – 32.8	32.7 – 52.3	51.6 – 78.6

Screen size		Lens model name and throw distance				
	Width × Height (cm)	NP40ZL	NP41ZL	NP43ZL	NP50ZL	NP44ML
30	66.4 × 37.4	—	—	—	—	(*)
40	88.6 × 49.8	—	—	—	—	
50	110.7 × 62.3	0.9 – 1.2	1.4 – 3.3	3.4 – 6.6	—	
60	132.8 × 74.7	1.0 – 1.5	1.7 – 4.0	4.0 – 7.9	0.8 – 1.0	
80	177.1 × 99.6	1.4 – 2.0	2.3 – 5.3	5.3 – 10.5	1.1 – 1.3	
100	221.4 × 124.5	1.7 – 2.5	2.9 – 6.7	6.6 – 13.1	1.3 – 1.7	
120	265.7 × 149.4	2.1 – 3.0	3.5 – 8.0	7.9 – 15.7	1.6 – 2.0	
150	332.1 × 186.8	2.6 – 3.7	4.3 – 10.0	9.9 – 19.6	2.0 – 2.5	
200	442.8 × 249.1	3.5 – 5.0	5.8 – 13.4	13.1 – 26.1	2.7 – 3.4	
240	531.3 × 298.9	4.2 – 6.0	7.0 – 16.1	15.7 – 31.3	3.3 – 4.1	
300	664.1 × 373.6	5.3 – 7.5	8.7 – 20.1	19.6 – 39.1	4.1 – 5.1	
400	885.5 × 498.1	7.1 – 10.0	11.7 – 26.8	26.1 – 52.2	5.5 – 6.8	
500	1106.9 × 622.6	8.9 – 12.5	14.6 – 33.5	32.6 – 65.2	6.9 – 8.6	

(*) See page 121 for NP44ML.

Calculation of the throw distance from the screen size

L: Throw distance

W: Screen width

Lens model name	Calculation formula (Zoom min to max)
NP11FL	$L = W \times 0.8$
NP12ZL	$L = W \times 1.2$ to $W \times 1.5$
NP13ZL	$L = W \times 1.5$ to $W \times 3.0$
NP14ZL	$L = W \times 2.9$ to $W \times 4.7$
NP15ZL	$L = W \times 4.6$ to $W \times 7.1$
NP40ZL	$L = W \times 0.8$ to $W \times 1.1$
NP41ZL	$L = W \times 1.3$ to $W \times 3.0$
NP43ZL	$L = W \times 3.0$ to $W \times 5.9$
NP50ZL	$L = W \times 0.6$ to $W \times 0.8$

Example: Throw distance when projecting on a 16:10 150" screen using the NP41ZL lens:

According to the "Lens types and throw distance (Aspect ratio 16:10)" table (→ page 113, 114), W (screen width) = 127"/323.1 cm.

The throw distance is $127"/323.1 \text{ cm} \times 1.3$ to $127"/323.1 \text{ cm} \times 3.0 = 165"/420.0 \text{ cm}$ to $381"/969.3 \text{ cm}$ (because of the zoom lens).

* Your calculated figure has a few percent margin of error because the calculation formula is approximate.

Lens shifting range

This projector is equipped with a lens shift function for adjusting the position of the projected image by buttons. The lens can be shifted within the range shown below.

- See page 25 for lens shift operations and precautions.
- See page xvi for Laser light radiation range.

Description of symbols: V indicates vertical (height of the projected image), H indicates horizontal (width of the projected image).

Desk/front projection

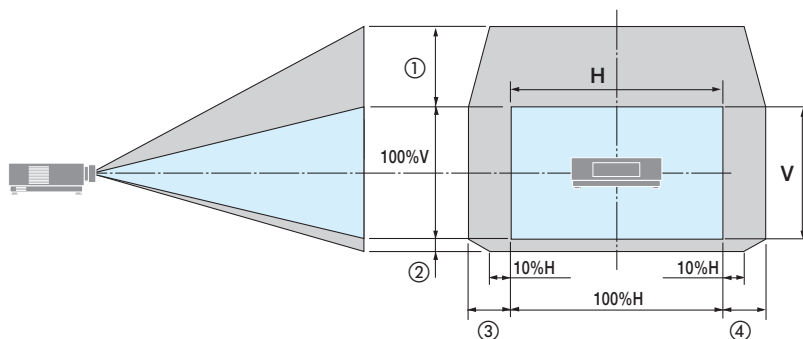

Ceiling/front projector

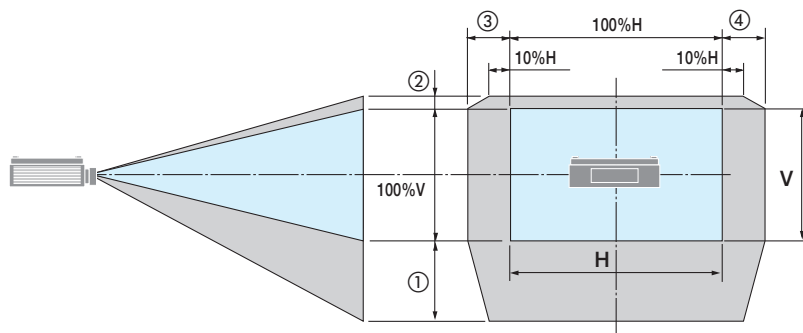

Number in the figure	Lens Unit	
	NP12ZL/NP13ZL/NP14ZL/NP15ZL	NP40ZL/NP41ZL/NP43ZL/NP50ZL
①	50%V	
②	10%V	
③	30%H *	20%H
④	30%H *	20%H

* The maximum adjustable range for lens shift (H) is 15%H when the NP13ZL lens is used on 150" or larger screen.

Example: When projecting on a 16:10 150" screen using the NP40ZL lens:

According to the "Lens types and throw distance (Aspect ratio 16:10)" (→ page 114), H (screen width) = 323.1 cm and V (screen height) = 201.9 cm

Adjustment range in the vertical direction: The projected image can be moved upward $0.50 \times 201.9 \text{ cm} \approx 111 \text{ cm}$ and downward $0.1 \times 201.9 \text{ cm} \approx 20 \text{ cm}$ (when the lens is at the center position).

Adjustment range in the horizontal direction: The projected image can be moved to the left $0.20 \times 323.1 \text{ cm} \approx 65 \text{ cm}$, and this applies to the right direction which means approx. 65 cm.

* Your calculated figure has a few percent margin of error because the calculation formula is approximate.

NOTE:

- Use NP11FL at the home position. If necessary, fine-adjust the position of the projected image using the lens shift function.
 - Fix the NP50ZL to the projector using the supplied support kit. Loosen the bolts of the support kit, you can adjust the lens shift.
 - Lens shift is not available for the NP44ML.
-

Throw distance when NP44ML is attached

- If there is a wall below the screen bottom, allow 0.3 m/12" or longer of L1 distance to install the projector.
- See page xvii for Laser light radiation range.

Aspect ratio 16:10

(Unit: inch)

Screen size	Width × Height (inches)	L1	L2	H1	H2
100	85 × 53	7	27	24	77
120	102 × 64	13	33	27	91
150	127 × 79	21	42	33	113
180	153 × 95	30	50	39	134
200	170 × 106	36	56	42	148
240	204 × 127	47	68	50	177
270	229 × 143	56	76	55	198
300	254 × 159	64	85	61	220
350	297 × 185	79	99	70	256
400	339 × 212	93	114	79	291

(Unit: m)

Screen size	Width × Height (cm)	L1	L2	H1	H2
100	215.4 × 134.6	0.17	0.70	0.60	1.95
120	258.5 × 161.5	0.32	0.84	0.70	2.31
150	323.1 × 201.9	0.54	1.06	0.84	2.86
180	387.7 × 242.3	0.76	1.28	0.98	3.40
200	430.8 × 269.2	0.90	1.43	1.07	3.77
240	516.9 × 323.1	1.20	1.72	1.26	4.49
270	581.6 × 363.5	1.42	1.94	1.40	5.04
300	646.2 × 403.9	1.64	2.16	1.54	5.58
350	753.9 × 471.2	2.00	2.52	1.78	6.49
400	861.6 × 538.5	2.37	2.89	2.01	7.40

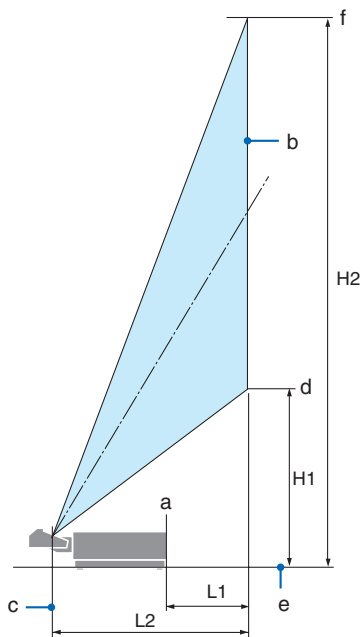

L1: The distance from the projector rear face (a) to the screen face (b)

L2: The distance from the center of the lens unit projection window (c) to the screen face (b)

H1: The height from the screen bottom (d) to the projector bottom face (e) (not including the tilt feet)

H2: The height from the screen top end (f) to the projector bottom face (e) (not including the tilt feet)

Aspect ratio 16:9

(Unit: inch)

Screen size	Width × Height	L1	L2	H1	H2
	(inches)				
80	70 × 39	2	22	23	62
100	87 × 49	8	28	27	76
120	105 × 59	14	34	31	90
150	131 × 74	22	43	38	111
180	157 × 88	31	52	44	133
200	174 × 98	37	58	49	147
240	209 × 118	49	70	57	175
270	235 × 132	58	79	64	196
300	261 × 147	67	87	70	218
350	305 × 172	82	102	81	253
400	349 × 196	96	117	92	288

(Unit: m)

Screen size	Width × Height	L1	L2	H1	H2
	(cm)				
80	177.1 × 99.6	0.04	0.57	0.57	1.57
100	221.4 × 124.5	0.19	0.72	0.68	1.93
120	265.7 × 149.4	0.34	0.87	0.79	2.29
150	332.1 × 186.8	0.57	1.09	0.96	2.83
180	398.5 × 224.1	0.80	1.32	1.13	3.37
200	442.8 × 249.1	0.95	1.47	1.24	3.73
240	531.3 × 298.9	1.25	1.77	1.46	4.45
270	597.7 × 336.2	1.47	1.99	1.62	4.99
300	664.1 × 373.6	1.70	2.22	1.79	5.53
350	774.8 × 435.8	2.07	2.59	2.07	6.43
400	885.5 × 498.1	2.45	2.97	2.34	7.33

Calculation of the throw distance from the screen size

L2: Distance between the center of the lens unit projection window and the screen face

W: Screen width

Lens model name	Calculation formula
NP44ML	$L2 = W \times 0.32$

Example: Throw distance when projecting on a 16:10 150" screen:

According to the "Aspect ratio 16:10" table (→ page 120), W (screen width) = 127"/323.1 cm.

The throw distance is $127"/323.1 \text{ cm} \times 0.32 = 41"/103.4 \text{ cm}$.

* Your calculated figure has a few percent margin of error because the calculation formula is approximate.

8-2. Compatible Input Signal List

HDMI/HDBaseT

Signal	Resolution (dots)	Aspect Ratio	Refresh Rate (Hz)
VGA	640 × 480	4 : 3	60
SVGA	800 × 600	4 : 3	60
XGA	1024 × 768	4 : 3	60
WXGA	1280 × 768	15 : 9	60
	1280 × 800	16 : 10	60
	1366 × 768	16 : 9	60
Quad-VGA	1280 × 960	4 : 3	60
SXGA	1280 × 1024	5 : 4	60
SXGA+	1400 × 1050	4 : 3	60
WXGA+	1440 × 900	16 : 10	60
WXGA++	1600 × 900	16 : 9	60
WSXGA++	1680 × 1050	16 : 10	60
WUXGA	1920 × 1200 *	16 : 10	60 Reduce Blanking
4K	3840 × 2160	16 : 9	23.98/24./25/29.97/30
HDTV(1080p)	1920 × 1080 *	16 : 9	50/60
HDTV(1080i)	1920 × 1080 *	16 : 9	50/60
HDTV(720p)	1280 × 720	16 : 9	50/60
SDTV(480p)	720 × 480	4:3/16:9	60
SDTV(576p)	720 × 576	4:3/16:9	50
SDTV(480i)	720 × 480	4:3/16:9	60
SDTV(576i)	720 × 576	4:3/16:9	50

* Native resolution

- With Advanced AccuBlend, the size of characters and ruled lines may be uneven and colors may be blurred.
- Upon shipment, the projector is set for signals with standard display resolutions and frequencies, but adjustments may be required depending on the type of computer.

8-3. Specifications

Model name		PV800UL-W/PV800UL-B	PV710UL-W/PV710UL-B
Method		Three primary color liquid crystal shutter projection method	
Specifications of main parts			
Liquid crystal panel	Size	0.76" × 3 (aspect ratio: 16:10)	
	Pixels ^{(*)1}	2,304,000 (1920 dots × 1200 lines)	
Projection lenses	Refer to the specifications of option lens (→ 125 page)		
	Zoom	Manual/Motorized	
	Focus	Manual/Motorized	
	Lens shifting	Motorized	
Light source		Laser diode with Phosphor	
Optical device		Optical isolation by dichroic mirror, combining by dichroic prism	
Light output ^{(*)2} ^{(*)3}		8000 lm	7100 lm
Screen size (throw distance)		30" - 500" (Throw distance depends on the lens)	
Color reproducibility		10-bit color processing (approx. 1.07 billion colors)	
Scanning frequency	Horizontal	15 kHz, 24 to 100 kHz	
	Vertical	24, 25, 30, 48 Hz, 50 to 85 Hz	
Input/output connectors			
HDMI	Video input	Type A × 2 LipSync, HDCP ^{(*)4} , 4K	
	Audio input	Sampling frequency: 32/44.1/48 kHz Sampling bit: 16/20/24 bit	
Ethernet/HDBaseT	Video input	RJ-45 × 1, 100BASE-TX, PLink class2, LipSync, HDCP ^{(*)4} , 4K	
	Audio input	Sampling frequency: 32/44.1/48 kHz Sampling bit: 16/20/24 bit	
Audio output		Stereo mini jack × 1 (Common to all signals)	
USB port		USB type A × 1	
LAN port		RJ-45 × 1, 10BASE-T/100BASE-TX, PLink class2	
Control Terminals			
PC control		D-Sub 9-pin × 1, RS232C	
Remote		Stereo mini jack × 1	
Built-in Speaker		Not applicable	
Usage environment ^{(*)5}		Operating temperature: 32 to 113°F (0 to 45°C) Operating humidity: 20 to 80% (with no condensation) Storage temperature: 14 to 122°F (-10 to 50°C) Storage humidity: 20 to 80% (with no condensation) Operating altitude: 0 to 2600 m/8500 feet (1600 to 2600 m/5500 to 8500 feet: Set [FAN MODE] to [HIGH ALTITUDE])	
Power supply		100-240 V AC, 50/60 Hz	
Power consumption		490 W (100-130 V AC) 467 W (200-240 V AC)	456 W (100-130 V AC) 434 W (200-240 V AC)

Model name		PV800UL-W/PV800UL-B	PV710UL-W/PV710UL-B
Power consumption (Standby state)			
STANDBY MODE	NORMAL	0.16 W (100-130 V AC) / 0.32 W (200-240 V AC)	
	NETWORK STANDBY	1.6 W (100-130 V AC) / 1.8 W (200-240 V AC)	
Rated input current		6.1 A (100-130 V AC) 2.5 A (200-240 V AC)	5.3 A (100-130 V AC) 2.2 A (200-240 V AC)
Power cord specification		15 A or higher	
External dimensions		19.6" (width) × 6.5" (height) × 16.0" (depth)/ 499 (width) × 164 (height) × 407 (depth) mm (not including protruding parts)	
		19.8" (width) × 6.6" (height) × 16.0" (depth)/ 503 (width) × 168 (height) × 407 (depth) mm (including protruding parts)	
Weight		24.7 lbs/11.2 kg (not including lens)	

*1 Effective pixels are more than 99.99%.

*2 Compliance with ISO21118-2020

*3 This is the brightness when lens unit NP41ZL (sold separately) is attached and [LIGHT MODE] is set to [NORMAL], [LIGHT ADJUST] is set to [100], and [PRESET] is set to [HIGH-BRIGHT]. Using [LIGHT ADJUST] will reduce brightness.

*4 If you are unable to view material via the HDMI input, this does not necessarily mean the projector is not functioning properly. With the implementation of HDCP, there may be cases in which certain content is protected with HDCP and might not be displayed due to the decision/intention of the HDCP community (Digital Content Protection, LLC).

Video: HDR, Deep Color, 8/10/12-bit, Lip Sync.

Audio: LPCM; up to 2 ch, sample rate 32/44.1/48 KHz, sample bit; 16/20/24-bit

HDMI: Supports HDCP 1.4

HDBaseT: Supports HDCP 1.4

*5 The projector's protection functions will activate depending on the temperature of the operating environment. (→ page 41)

• For additional information visit:

US: <https://www.sharpnecdisplays.us>

Europe: <https://www.sharpnecdisplays.eu>

Global: <https://www.sharp-nec-displays.com/global/>

For information on our optional accessories, visit our website or see our brochure.

The specifications are subject to change without notice.

Option lens (sold separately)

NP11FL	Manual focus
	(Throw ratio 0.81 : 1, F2.3, f=13.2 mm)
NP12ZL	Motorized lens shift, Manual zoom, Manual focus
	(Throw ratio 1.16–1.52 : 1, F2.20–2.69, f=19.4–25.3 mm)
NP13ZL	Motorized lens shift, Manual zoom, Manual focus
	(Throw ratio 1.46–2.95 : 1, F1.70–2.37, f=24.4–48.6 mm)
NP14ZL	Motorized lens shift, Manual zoom, Manual focus
	(Throw ratio 2.90–4.68 : 1, F2.20–2.64, f=48.5–77.6 mm)
NP15ZL	Motorized lens shift, Manual zoom, Manual focus
	(Throw ratio 4.59–7.02 : 1, F2.20–2.70, f=76.6–116.5 mm)
NP40ZL	Motorized lens shift, Motorized zoom , Motorized focus
	(Throw ratio 0.79–1.11 : 1, F2.0–2.5, f=13.3–18.6 mm)
NP41ZL	Motorized lens shift, Motorized zoom , Motorized focus
	(Throw ratio 1.30–3.02 : 1, F1.7–2.0, f=21.8–49.8 mm)
NP43ZL	Motorized lens shift, Motorized zoom, Motorized focus
	(Throw ratio 2.99–5.93 : 1, F2.2–2.6, f=49.7–99.8 mm)
NP50ZL	Motorized lens shift, Motorized zoom, Motorized focus
	(Throw ratio 0.60–1.75 : 1, F1.9–2.1, f=10.2–12.8 mm)
NP44ML	Motorized focus
	(Throw ratio 0.32 : 1, F2.0, f=6.27 mm)

NOTE:

- The above throw ratio is for projecting on 100" screen.
- Use NP11FL at the home position. If necessary, fine-adjust the position of the projected image using the lens shift function.
- Fix the NP50ZL to the projector using the supplied support kit. Loosen the bolts of the support kit, you can adjust the lens shift.
- Fix the NP44ML to the projector using the separately sold support kit (NP01LK). Lens shift is not available for the NP44ML.

8-4. Cabinet Dimensions

Unit: mm (inch)

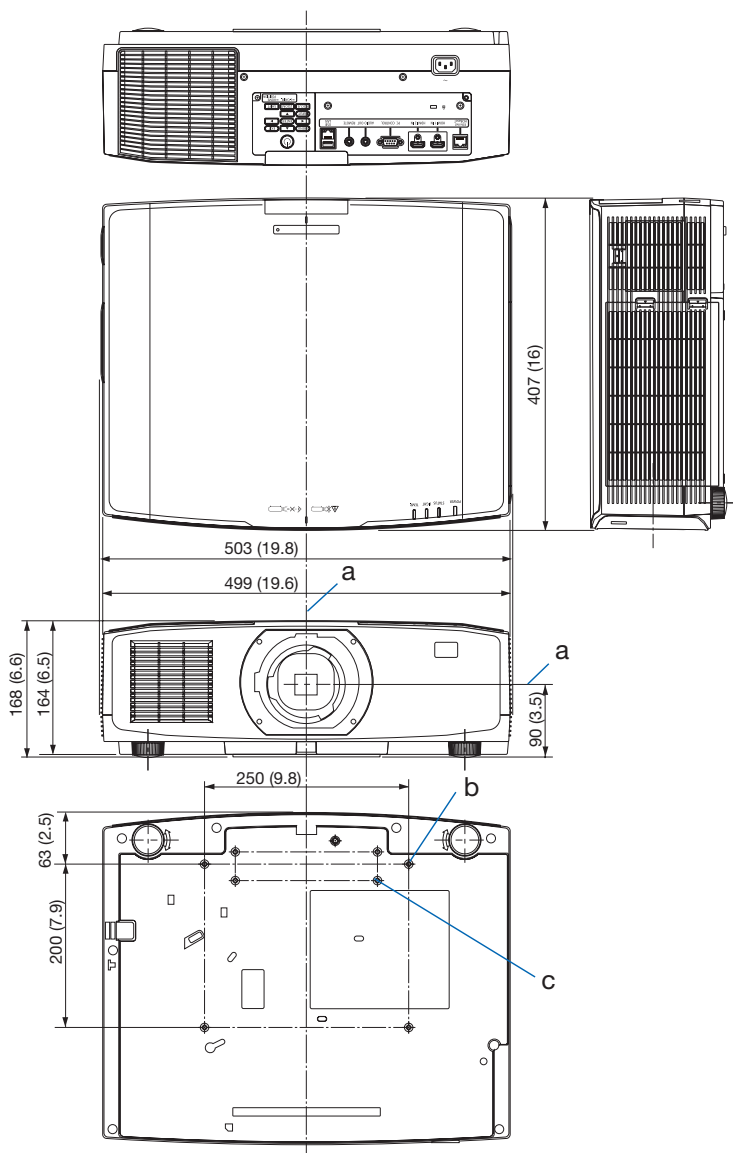

- a: Lens center / b: Screw holes for attaching the ceiling mount unit /
 c: Screw holes for attaching the support kit for NP50ZL

8-5. Pin assignments and signal names of main connectors

HDMI 1 IN/HDMI 2 IN Connector (Type A)

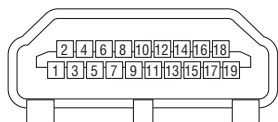

Pin No.	Signal
1	TMDS Data 2+
2	TMDS Data 2 Shield
3	TMDS Data 2–
4	TMDS Data 1+
5	TMDS Data 1 Shield
6	TMDS Data 1–
7	TMDS Data 0+
8	TMDS Data 0 Shield
9	TMDS Data 0–
10	TMDS Clock +
11	TMDS Clock Shield
12	TMDS Clock–
13	CEC
14	Disconnection
15	SCL
16	SDA
17	DDC/CEC grounding
18	+5 V power supply
19	Hot plug detection

Ethernet/HDBaseT Port (RJ-45)

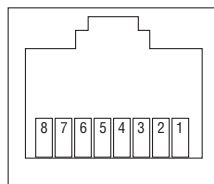

Pin No.	Signal
1	TxD+/HDBT0+
2	TxD–/HDBT0–
3	RxD+/HDBT1+
4	Disconnection/HDBT2+
5	Disconnection/HDBT2–
6	RxD–/HDBT1–
7	Disconnection/HDBT3+
8	Disconnection/HDBT3–

USB Port (Type A)

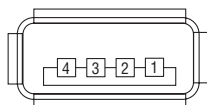

Pin No.	Signal
1	V _{BUS}
2	D–
3	D+
4	Grounding

PC CONTROL Port (D-Sub 9 Pin)

Pin No.	Signal
1	Unused
2	RxD reception data
3	TxD transmission data
4	Unused
5	Grounding
6	Unused
7	RTS transmission request
8	CTS transmission allowed
9	Unused

8-6. Changing the Background Logo (Virtual Remote Tool)

This will help you perform operations such as projector's power on or off and signal selection via a LAN connection. It is also used to send an image to the projector and register it as the logo data of the projector. After registering it, you can lock the logo to prevent it from changing.

Control Functions

Power On/Off, signal selection, picture freeze, picture mute, audio mute, Logo transfer to the projector, and remote control operation on your PC.

Virtual Remote screen



Remote Control Window

Use this button for changing the background logo.



Toolbar

For getting the Virtual Remote Tool, please visit our web site and download it:

<https://www.sharp-nec-displays.com/dl/en/index.html>

NOTE:

- Remote Control Window is not available for changing the background logo.
Please see the HELP menu of the Virtual Remote Tool about how to display the Toolbar.
- Logo data (graphics) that can be sent to the projector with Virtual Remote Tool has the following restrictions:
(Only via serial or LAN connection)
 - * Format: JPEG or PNG
 - * Resolution: Below the panel resolution of the projector
WUXGA (1920 × 1200)
 - * File size: 1 megabyte or less
- Logo data (image) sent using the Virtual Remote Tool will be displayed in the center with the surrounding area in black.

8-7. Portrait projection (vertical orientation)

Portrait screens from a computer can be projected by installing the projector in a vertical orientation.

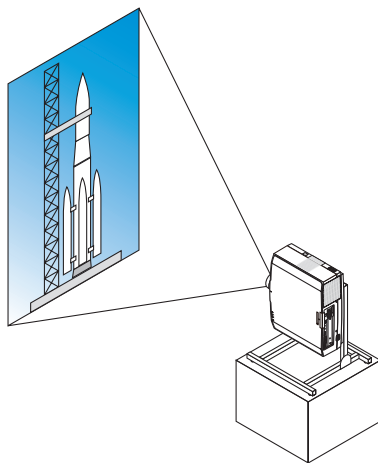

Precautions during installation

- Please do not install the projector in a vertical orientation on top of the floor or table on its own. The intake vent may be obstructed, resulting in the projector getting warm and the possibility of fire and malfunction occurring.
- A stand for supporting the projector needs to be made for this purpose. In this case, the stand must be designed such that the center of gravity of the projector is located well within the legs of the stand. If not, the projector may fall over and result in injury, damage and malfunction.
- Take measures to prevent the projector from falling in anticipation of a malfunction occurring in the projector or stand.

Design and manufacturing conditions for the stand

Please engage an installation service provider for the design and manufacture of the customized stand to be used for portrait projection. Please ensure that the following are complied with when designing the stand.

1. Maintain an opening of at least 315×150 mm so as not to obstruct the intake vent / filter of the projector.
2. Maintain a distance of at least 130 mm between the projector intake vent and the floor (for the opening of the filter cover).
3. Use the four screw holes at the back of the projector to secure it to the stand.

Screw hole center dimension: 200×250 mm

Screw hole dimension on the projector: M4 with a maximum depth of 8 mm.

* Please design the stand such that the rear legs at the back of the projector do not contact the stand. The front legs can be turned and removed.

4. Horizontal adjustment mechanism (for example, bolts and nuts in four locations)
5. Please design the stand such that it does not topple over easily.

Reference drawings

* The drawing showing the dimensional requirements is not an actual stand design drawing.

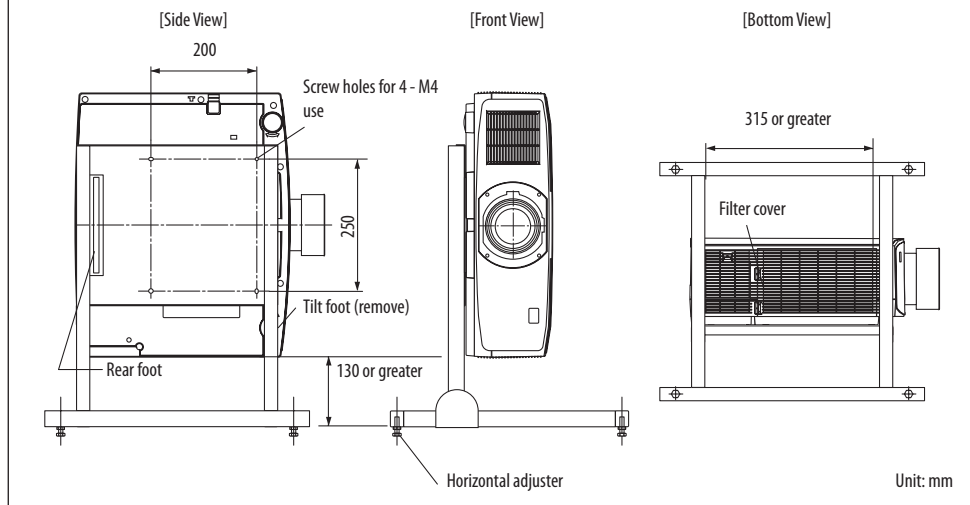

8-8. Troubleshooting





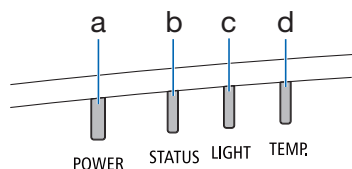























This section helps you resolve problems you may encounter while setting up or using the projector.











Feature of each indicator



a: POWER indicator
 b: STATUS indicator
 c: LIGHT indicator
 d: TEMP. indicator

Indicator Message (Status message)

POWER	STATUS	LIGHT	TEMP.	Projector status
 Off	 Off	 Off	 Off	Power is off
 Orange (Blink ^{*1})	 Off	 Off	 Off	In the state of Standby ([STANDBY MODE] is [NORMAL])
 Orange (Light)	 Off	 Off	 Off	In the state of Standby ([STANDBY MODE] is [NETWORK STANDBY])
 Green (Light)	 Off	 Off	 Off	In the state of Sleep
 Blue (Light)	 Off	 Green (Light)	 Off	Powered state ([LIGHT MODE] is [NORMAL])
 Blue (Light)	 Off	 Green (Blink ^{*2})	 Off	Powered state ([LIGHT MODE] is [SILENT] or [LONG LIFE])
Status varies	 Orange (Blink ^{*3})	Status varies	 Off	[LENS CALIBRATION] implement request.
 Blue (Light)	 Green (Blink ^{*3})	Status varies	 Off	Performing the lens calibration

POWER	STATUS	LIGHT	TEMP.	Projector status
 Blue (Light)	Status varies	 Off	 Off	Shutter function is activating
 Blue (Blink* ²)	 Off	Status varies	 Off	[OFF TIMER] is activated (Powered state)
 Blue (Blink* ⁴)	 Off	 Off	 Off	Preparing for powering [ON]













*1 Repetition to light on for 1.5 seconds / off for 7.5 seconds

*2 Repetition to light on for 2.5 seconds / off for 0.5 seconds

*3 Repetition to light on for 0.5 seconds / off for 0.5 seconds / on for 0.5 seconds / off for 2.5 seconds

*4 Repetition to light on for 0.5 seconds / off for 0.5 seconds

Indicator Message (Error message)

POWER	STATUS	LIGHT	TEMP.	Projector status	Procedure
 Blue (Light)	 Orange (Light)	Status varies	 Off	A button has been pressed while the [CONTROL PANEL LOCK] is activated.	The [CONTROL PANEL LOCK] is activated. The setting must be canceled to operate the projector. (→ page 78)
				ID numbers for the projector and the remote control do not match.	Check the [CONTROL ID] (→ page 79)
 Blue (Light)	 Off	 Orange (Light)	 Orange (Light)	Temperature problem	Ambient temperature is high. The projector's protection functions will activate depending on the temperature of the operating environment. Lower the room temperature.
 Red (Blink*5)	 Off	 Off	 Off	Temperature problem	Ambient temperature is out of the operation temperature. Check if any obstruction stays near the exhaust vent.
 Red (Light)	Status varies	Status varies	 Off	Error requiring service support	Contact your dealer or service personnel. Make sure to check and inform indicator status for asking to repair.

*5 Repetition to light on for 0.5 seconds / off for 0.5 seconds

When the thermal protector is activated:

When inside temperature of the projector becomes too high or low, the POWER indicator start to red blink in a short cycle. After this happened, the thermal protector will activate and the projector may be turned off.

In this case, please take the below measures:

- Pull out the power plug from the wall inlet.
- Place the projector in cool place if it has been placed in high ambient temperature.
- Clean the exhaust vent if dust has accumulated on.
- Leave the projector for about one hour until inside temperature gets lower.

Common Problems & Solutions

(→ “Indicator Message” on page 132.)

Problem	Check These Items
Does not turn on or shut down	<ul style="list-style-type: none"> • Check that the power cord is plugged in and that the power button on the projector cabinet or the remote control is on. (→ pages 17, 19) • Check to see if the projector has temperature error. If projector inside temperature is too hot or cool, it disabled to turn on the projector as the protection. Wait for a moment and try turn on the projector again. • Set [FAN MODE] to [HIGH ALTITUDE] when using the projector at altitudes approximately 5500 feet/1600 meters or higher. Using the projector at altitudes approximately 5500 feet/1600 meters or higher without setting to [HIGH ALTITUDE] can cause the projector to overheat and the projector could shut down. If this happens, wait a couple minutes and turn on the projector. (→ page 82) If you turn on the projector immediately after the light module is turned off, the fans run without displaying an image for some time and then the projector will display the image. Wait for a moment. • In case it's hard to think the trouble is not caused on the above mentioned conditions, unplug the power cord from the outlet. Then wait 5 minutes before plugging it in again. (→ page 35)
Will turn off	<ul style="list-style-type: none"> • Ensure that the [OFF TIMER] or [AUTO POWER OFF] is off. (→ page 72, 85)
No picture	<ul style="list-style-type: none"> • Check if the appropriate input is selected. (→ page 22) If there is still no picture, press the INPUT button or one of the input buttons again. • Ensure your cables are connected properly. • Use menus to adjust the brightness and contrast. (→ page 69) • Reset the settings or adjustments to factory preset levels using the [RESET] in the Menu. (→ page 90) • Enter your registered keyword if the Security function is enabled. (→ page 49) • If the HDMI input signal cannot be displayed, try the following. Reinstall your driver for the graphics card built in your computer, or use the updated driver. For reinstalling or updating your driver, refer to the user guide accompanied with your computer or graphics card, or contact the support center for your computer manufacturer. Install the updated driver or OS on your own responsibility. We are not liable for any trouble and failure caused by this installation. • The signal may not be supported depending on the HDBaseT transmission device. In addition, RS232C interface may not be supported. • Be sure to connect the projector and notebook PC while the projector is in standby mode and before turning on the power to the notebook PC. In most cases the output signal from the notebook PC is not turned on unless connected to the projector before being powered up. * If the screen goes blank while using your remote control, it may be the result of the computer's screen-saver or power management software.
Picture suddenly becomes dark	<ul style="list-style-type: none"> • A hot room may trigger the projector's protection functions, which can result in a temporary reduction in luminance (brightness). Reduce the temperature in the room.
Color tone or hue is unusual	<ul style="list-style-type: none"> • Check if an appropriate color is selected in [WALL COLOR]. If so, select an appropriate option. (→ page 72) • Adjust [HUE] in [PICTURE]. (→ page 69)
Image isn't square to the screen	<ul style="list-style-type: none"> • Reposition the projector to improve its angle to the screen. (→ page 24) • Perform [KEYSTONE] when the trapezoid is distorted. (→ page 43)

Problem	Check These Items
Picture is blurred	<ul style="list-style-type: none"> • Adjust the focus. (→ page 27) • Reposition the projector to improve its angle to the screen. (→ page 24) • Ensure that the distance between the projector and screen is within the adjustment range of the lens. (→ page 112) • Has the lens been shifted by an amount exceeding the guaranteed range? (→ page 118) • Condensation may form on the lens if the projector is cold, brought into a warm place and is then turned on. Should this happen, let the projector stand until there is no condensation on the lens.
Flicker appears on screen	<ul style="list-style-type: none"> • Set [FAN MODE] to other than [HIGH ALTITUDE] mode when using the projector at altitudes approximately 5500 feet/1600 meters or lower. Using the projector at altitudes less than approximately 5500 feet/1600 meters and setting to [HIGH ALTITUDE] can cause the light module to overcool, causing the image to flicker. Switch [FAN MODE] to [AUTO]. (→ page 82)
Image is scrolling vertically, horizontally or both	<ul style="list-style-type: none"> • Check the computer's resolution and frequency. Make sure that the resolution you are trying to display is supported by the projector. (→ page 122)
Remote control does not work	<ul style="list-style-type: none"> • Install new batteries. (→ page 13) • Make sure there are no obstacles between you and the projector. • Stand within 20 m/787 inch of the projector. (→ page 14)
Indicator is lit or blinking	<ul style="list-style-type: none"> • See the Indicator Message. (→ page 132)

For more information contact your dealer.

8-9. PC Control Codes and Cable Connection

PC Control Codes

Function	Code Data							
POWER ON	02H	00H	00H	00H	00H	02H		
POWER OFF	02H	01H	00H	00H	00H	03H		
INPUT SELECT HDMI1	02H	03H	00H	00H	02H	01H	A1H	A9H
INPUT SELECT HDMI2	02H	03H	00H	00H	02H	01H	A2H	AAH
INPUT SELECT HDBaseT	02H	03H	00H	00H	02H	01H	BFH	C7H
PICTURE MUTE ON	02H	10H	00H	00H	00H	12H		
PICTURE MUTE OFF	02H	11H	00H	00H	00H	13H		
SOUND MUTE ON	02H	12H	00H	00H	00H	14H		
SOUND MUTE OFF	02H	13H	00H	00H	00H	15H		

NOTE:

- Contact your local dealer for a full list of the PC Control Codes if needed.

Cable Connection

Communication Protocol

Baud rate	38400/19200/9600/4800 bps
Data length	8 bits
Parity	No parity
Stop bit	1 bit
X on/off	None
Communications procedure	Full duplex

NOTE:

- Depending on the equipment, a lower baud rate may be recommended for long cable runs.

PC Control Terminal (D-Sub 9P)

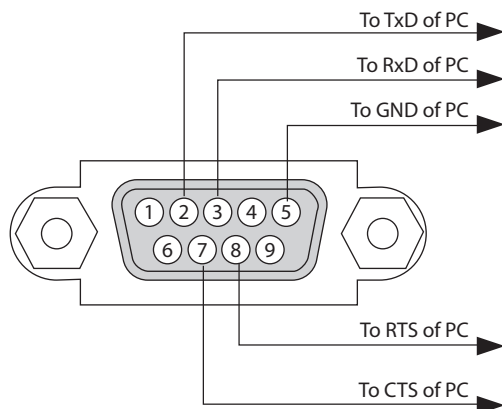

NOTE:

- Pins 1, 4, 6 and 9 are no used.
 - Jumper “Request to Send” and “Clear to Send” together on both ends of the cable to simplify cable connection.
 - For long cable runs it is recommended to set communication speed within projector menus to 9600 bps.
-

8-10. About the ASCII Control Command

This device supports the common ASCII Control Command for controlling our projector and monitor. Please visit our web site for detailed information about the command.

https://www.sharp-nec-displays.com/dl/en/pj_manual/lineup.html

How to connect with an external device

There are two methods to connect the projector with an external device such as a computer.

1. Connection thru the serial port.

Connects the projector to a computer by a serial cable (a cross cable).

2. Connection via network (LAN/HDBaseT)

Connects the projector to a computer by a LAN cable.

Concerning to the type of LAN cable, please ask to your network administrator.

Connection interface

1. Connection thru the serial port.

Communication Protocol

Item	Information
Baud rate	38400/19200/9600/4800 bps
Data length	8 bits
Parity bit	No parity
Stop bit	1 bit
Flow control	None
Communications procedure	Full duplex

2. Connection via network

Communication Protocol (Connection via LAN)

Item	Information
Communication speed	Set automatically (10/100 Mbps)
Supported standard	IEEE802.3 (10BASE-T) IEEE802.3u (100BASE-TX, Auto-Negotiation)

Use the TCP port number 7142 for transmitting and receiving command.

Communication Protocol (Connection via HDBaseT)

Item	Information
Communication speed	100 Mbps
Supported standard	IEEE802.3u (100BASE-TX, Auto-Negotiation)

Use the TCP port number 7142 for transmitting and receiving command.

Parameters for this device

Input command

Input terminal	Response	Parameter
HDMI1	hdmi1	hdmi1 or hdmi
HDMI2	hdmi2	hdmi2
HDBaseT	hdbaset	hdbaset or hdbaset1

Status command

Response	Error Status
error:temp	Temperature error
error:fan	Fan trouble
error:light	Light source trouble
error:system	System trouble

8-11. Troubleshooting Check List

Before contacting your dealer or service personnel, check the following list to be sure repairs are needed also by referring to the “Troubleshooting” section in your user’s manual. This checklist below will help us solve your problem more efficiently.

* Print this page and the next page for your check.

Frequency of occurrence:

always sometimes (How often? _____) other (_____)

Power

- No power (POWER indicator does not light blue). See also “Status Indicator (STATUS)”.
- Power cord’s plug is fully inserted into the wall outlet.
- No power even though you press and hold the POWER button.
- Shut down during operation.
 - Power cord’s plug is fully inserted into the wall outlet.
 - [AUTO POWER OFF] is turned off (only models with the [AUTO POWER OFF] function).
 - [OFF TIMER] is turned off (only models with the [OFF TIMER] function).

Video and Audio

- No image is displayed from your PC or video equipment to the projector.
 - Still no image even though you connect the projector to the PC first, then start the PC.
 - Enabling your notebook PC’s signal output to the projector.
 - A combination of function keys will enable/disable the external display. Usually, the combination of the “Fn” key along with one of the 12 function keys turns the external display on or off.
 - No image (blue or black background, no display).
 - Still no image even though you carry out [RESET] in the projector’s menu.
 - Signal cable’s plug is fully inserted into the input terminal
 - A message appears on the screen. (_____)
 - The source connected to the projector is active and available.
 - Still no image even though you adjust the brightness and/or the contrast.
 - Input source’s resolution and frequency are supported by the projector.
- Image is too dark.
 - Remains unchanged even though you adjust the brightness and/or the contrast.
- Image is distorted.
 - Image appears to be trapezoidal (unchanged even though you carry out the [KEystone] adjustment).
- Parts of the image are lost.
 - Still unchanged even though you carry out [RESET] in the projector’s menu.
- Image is shifted in the vertical or horizontal direction.
 - Horizontal and vertical positions are correctly adjusted on a computer signal.
 - Input source’s resolution and frequency are supported by the projector.
 - Some pixels are lost.
- Image is flickering.
 - Still unchanged even though you carry out [RESET] in the projector’s menu.
 - Image shows flickering or color drift on a computer signal.
 - Still unchanged even though you change [FAN MODE] from [HIGH ALTITUDE] to [AUTO].
- Image appears blurry or out of focus.
 - Still unchanged even though you checked the signal’s resolution on PC and changed it to projector’s native resolution.
 - Still unchanged even though you adjusted the focus.
- No sound.
 - Audio cable is correctly connected to the audio input of the projector.
 - Still unchanged even though you adjusted the volume level.
 - AUDIO OUT is connected to your audio equipment (only models with the AUDIO OUT terminal).

Other

- Remote control does not work.
 - No obstacles between the sensor of the projector and the remote control.
 - Projector is placed near a fluorescent light that can disturb the infrared remote controls.
 - Batteries are new and are not reversed in installation.
- Buttons on the projector cabinet do not work (only models with the [CONTROL PANEL LOCK] function)
 - [CONTROL PANEL LOCK] is not turned on or is disabled in the menu.
 - Still unchanged even though you press and hold the EXIT button over 10 seconds.

In the space below please describe your problem in detail.

Information on application and environment where your projector is used

Projector

Model number:

Serial No.:

Date of purchase:

Light module operating time (hours):

LIGHT MODE: NORMAL SILENT
 LONG LIFE

Information on input signal:

Horizontal synch frequency [] kHz

Vertical synch frequency [] Hz

Synch polarity H (+) (-)

V (+) (-)

Synch type Separate Composite
 Sync on Green

Indicator Message:

POWER Blinks in Blue Green Orange Red
[] cycles

Lights in Blue Green Orange Red

STATUS Blinks in Blue Green Orange Red
[] cycles

Lights in Blue Green Orange Red

LIGHT Blinks in Blue Green Orange Red
[] cycles

Lights in Blue Green Orange Red

TEMP. Blinks in Blue Green Orange Red
[] cycles

Lights in Blue Green Orange Red

Remote control model number:

Signal cable

NEC standard or other manufacturer's cable?

Model number: _____ Length: _____ inch/m

Distribution amplifier

Model number: _____

Switcher

Model number: _____

Adapter

Model number: _____

Installation environment

Screen size: _____ inch

Screen type: White matte Beads Polarization
 Wide angle High contrast

Throw distance: _____ feet/inch/m

Orientation: Ceiling mount Desktop

Power outlet connection:

- Connected directly to wall outlet
- Connected to power cord extender or other (the number of connected equipment _____)
- Connected to a power cord reel or other (the number of connected equipment _____)

Computer

Manufacturer:

Model number:

Notebook PC / Desktop

Native resolution:

Refresh rate:

Video adapter:

Other:

Video equipment

VCR, DVD player, Video camera, Video game or other

Manufacturer:

Model number:

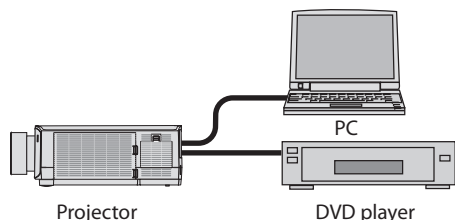

8-12. REGISTER YOUR PROJECTOR! (for residents in the United States, Canada, and Mexico)

Please take time to register your new projector. This will activate your limited parts and labor warranty and InstaCare service program.

Visit our web site at <https://www.sharpnecdisplays.us>, click on support center/register product and submit your completed form online.

Upon receipt, we will send a confirmation letter with all the details you will need to take advantage of fast, reliable warranty and service programs from the industry leader, Sharp NEC Display Solutions of America, Inc.

NEC